

UPS **MILITARY** **FIELD-GRADE**

UNINTERRUPTIBLE POWER SUPPLY

Operator's Guide *3-Phase UPS-1500 Series*

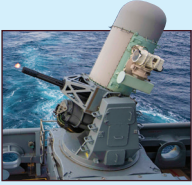

UPS-1500-S-1U-T



*N+M Redundancy
(optional)*



Made in USA

SynQor[®]
Advancing The Power Curve[®]

Table of Contents

SECTION I

WARNINGS

Hazardous Voltages	4
Hazardous Energies	5
Battery Pack.....	6
Protection from the Environment	6
User Serviceable Parts.....	6

SECTION II

GENERAL PRODUCT INFORMATION

Product Description	7
Product Topology	8
Part Numbering Scheme and Options.....	10
Product Specifications.....	12
1U Mechanical Diagram.....	13
Electrical Characteristics.....	14
UPS Efficiency	15
Total Output Power that can be derived from the AC INPUT.....	16
Power Cable Wiring Diagram.....	18
Power Cable Wire Size	19

SECTION III

OPERATION

Set-Up	21
Start-Up.....	22
Shut-Down	22
Power Cable Connections/Disconnections While Operating.....	23
Cooling System	24
Front Panel Indicators	25
LEDs	25
Audible alarm.....	30
Hot Swapping the Battery Pack	30
Operating Environment.....	31

SECTION IV

MULTIPLE UPS CONFIGURATIONS

General Considerations	32
Standard Paralleling “F” Option	33
Expanded Paralleling “R” Option.....	33
Parallel Configurations of the AC OUTPUTS: Up to Three Units	35
Multi-unit Configurations.....	35
Parallel Configurations of the AC OUTPUTS: Up to 32 Unit “R” option	36

SECTION IV (CONTINUED) MULTIPLE UPS CONFIGURATIONS

Parallel Connection of the AC OUTPUTS	37
Two UPS units with AC OUTPUTS Paralleled	37
Three UPS units with AC OUTPUTS Paralleled.....	38
Series Split Phase Connection of AC OUTPUTS	39
3-Phase Connection of AC OUTPUTS	40
Parallel Connection of DC OUTPUTS.....	41
Connection of the AC and/or DC INPUTS.....	41
Multi-unit AC OUTPUT “ON/OFF” Control – Standard Parallel (“F” option).....	41
Multi-unit AC OUTPUT “ON/OFF” Control – Expanded Parallel (“R” option).....	42
AC OUTPUT Neutral Grounding.....	42
Wiring Caution	42

SECTION V

BATTERY PACK

Battery Technology	43
Electronic Circuitry within the Battery Pack.....	43
Battery Capacity.....	44
Storage of the Battery Pack	45
Battery Pack Replacement	45
Handling the Battery Pack.....	45

SECTION VI

CONTROL INTERFACE DETAILS

Control Cable Connections	47
Internal User I/O Circuits	48
Remote On/Off Switch Connections.....	48
Digital Input/Output Control Signals.....	49
RS232 Serial Interface	50
Ethernet Interface	51

SECTION VII

MAINTENANCE

Battery	52
Fans.....	52
Cleaning	52

SECTION VIII

TROUBLE-SHOOTING GUIDE

Fault Conditions.....	53
-----------------------	----

Hazardous Voltages

The **INPUT and OUTPUT Power** connectors and cables of the SynQor UPS may have voltages that are unsafe. **INJURY OR DEATH ON CONTACT** may result. Appropriate safety precautions should be taken. All connections should be made in accordance with **LOCAL ELECTRICAL CODES**.

- The UPS **CHASSIS** should be connected to earth or system ground with Ground Stud on the rear panel, see mechanical diagrams.
- For the **AC INPUT** cable and connector:
 - Do not assume that a hazardous voltage is not present at the terminals of the AC INPUT connector, even if the UPS appears to be “OFF”.
 - Do not make contact with the terminals of the AC INPUT connector.
 - Always connect the cable to the UPS before it is connected to the source of AC power.
 - Always disconnect the AC INPUT cable from the source of AC power before disconnecting it from the UPS.
 - If the AC INPUT cable is connected to the source of AC power and not connected to the UPS, do not contact the exposed terminals of the AC INPUT cable.
 - Do not assume that the source of AC power is not present.
 - Connections between the AC INPUT cable and the source of AC power should not be accessible.
- For the **AC OUTPUT** cable and connector:
 - Do not assume that a hazardous voltage is not present at the terminals of the AC OUTPUT connector, even if the UPS appears to be “OFF”.
 - Do not make contact with the terminals of the AC OUTPUT connector.
 - Connect the AC OUTPUT cable to the UPS before the UPS is turned “ON”.
 - If connection of the load to the AC OUTPUT cable has exposed conductors, make this connection before connecting the AC OUTPUT cable to the UPS.
 - Connections between the AC OUTPUT cable and the load should not be accessible.
- For the **DC INPUT** cable and connector (if present):
 - The rated DC INPUT voltage of the UPS is below the level considered hazardous.
 - The DC INPUT terminals of the UPS are isolated from the AC INPUT and AC OUTPUTS with reinforced safety insulation.
 - However, never assume the terminals of the DC INPUT connector or the wires of the DC INPUT cable are safe to contact, *not even if the UPS or DC INPUT source appears to be “OFF”*.

- For the **DC OUTPUT** cable and connector (if present):
 - The rated DC OUTPUT voltage of the UPS is below the level considered hazardous.
 - The DC OUTPUT terminals of the UPS are isolated from the AC INPUT and AC OUTPUTS with reinforced safety insulation.
 - However, never assume the terminals of the DC OUTPUT connector or the wires of the DC OUTPUT cable are safe to contact, not even if the UPS appears to be “OFF”.
- For the **BATTERY PACK** (if not inserted into the UPS):
 - When the battery pack is not inserted into the UPS, the battery is internally disconnected from the power pins of the battery pack’s connector.
 - Even if this disconnection were not present, the DC voltage of the battery is below the level considered hazardous.
 - Do not apply external voltages to the pins of an exposed battery pack connector. It is not possible to charge the battery pack from an external source. An external voltage could damage the pack’s internal control circuitry.

Hazardous Energies

The **INPUT and OUTPUT Power** connectors and cables of the SynQor UPS may be the source of high levels of energy. Do not inappropriately make electrical contact between any terminal of a connector and another, or between any wire of a cable and another, or between any terminal or wire and the UPS’s chassis or ground. **DAMAGING ELECTRICAL ARCS** may result upon contact. Care should be taken to avoid accidental electrical contacts of any sort with the battery connector.

When the **BATTERY PACK** is not inserted into the UPS, the battery is internally disconnected from the power pins of the battery pack’s connector. An electrical contact between any two of these power pins or between any power pin and ground should therefore not be damaging the pack. However, care should be taken to avoid accidental electrical contacts of this sort.

Battery Pack

The individual **LITHIUM ION BATTERIES** contained in the SynQor battery pack are sealed units that are further mechanically protected by the battery pack's chassis and electrically protected by the battery pack's electronic circuitry. Under normal conditions they do not pose a hazard, but they should not be physically, thermally or electrically abused.

The **TRANSPORT** of the battery pack must comply with applicable regulations of the locality. See "Battery Pack - Handling the Battery Pack".

The battery pack should be **DISPOSED** in accordance with applicable regulations of the locality or **RETURNED** to a factory-authorized Service Center.

Emergency response contact information for battery damage, leaks, smoke, or fires can be found at the following link: <http://www.SynQor.com/UPS/documents/Contact.pdf>. Please contact the SynQor factory for all other questions regarding the UPS battery pack.

CAUTION: Do not dispose of batteries in a fire. The batteries may explode.

CAUTION: Do not open or mutilate batteries. Released electrolyte is harmful to the skin and eyes. It may be toxic.

Always use the proper SynQor battery pack. See the battery replacement chart on page 45.

Protection from the Environment

The SynQor UPS is a ruggedly built product having its electronics and battery contained in sealed chambers. The UPS is capable of withstanding harsh levels of mechanical acceleration, shock and vibration, temperature and pressure variations, and exposure to water, salt, sand and dust within the levels specified in the data sheet. **THESE LEVELS SHOULD NOT BE EXCEEDED.**

Do not obstruct the air intake in the front of the UPS or the fan exhausts in the rear panel of the UPS while the UPS is operating.

User Serviceable Parts

UPS fans are user replaceable with kits available from SynQor. Please contact the SynQor factory for obtaining fan replacement kits and instructions (Replaceable Fan Module SYN-9450). The SynQor UPS has no other user serviceable parts inside. **DO NOT REMOVE the cover of the UPS** or any of its connectors. Other than fan assembly replacement, only factory trained personnel should perform unit repairs.

Product Description

The SynQor UPS-1500 3-Phase Series is an advanced technology military-grade uninterruptible power supply (UPS) that uses lithium ion batteries and highly efficient power electronic circuitry to achieve a high power level and battery run-time in a low-profile, low-weight, rack-mountable package. It provides voltage and frequency conditioning, electrical isolation, and power flow smoothing between the power inputs and its power outputs. It provides battery backed-up power when other power sources are not present.

A communication/control port is available to permit monitoring and control by a host computer system. Front panel LEDs and an audible alarm provide information on the status of the UPS and the battery pack.

The UPS-1500 3-Phase Series products draw power from a 200 V_{L-L}/115 V_{L-N} AC INPUT connected in delta. Note that since the UPS input is in delta, no physical neutral input connection exists. Line to neutral **“INPUT”** voltages discussed throughout this document are conceptual, not physical. Line to neutral voltages will be referred in this document as line to virtual neutral **“vN”** for discussion purposes.

The UPS grants a high degree of flexibility in terms of supplying power to the unit. The AC INPUT accepts a wide frequency range (45-800 Hz). An optional 28 V nominal DC INPUT may also be used. The AC INPUT has priority over the DC INPUT. The UPS provides up to 1500 VA and 1250 W of AC OUTPUT power at 115 or 230 Vac. The pure sine wave AC OUTPUT voltage can drive any non-linear load with a crest factor up to 2.5, and any load power factor from 0.0 to 1.0. The UPS-1500 also provides several options on the unit's output configuration. There are two optional DC outputs, available at various voltage and power levels. However, note that the combined AC and the DC option output power is limited to 1250 W total.

The electronic circuitry within the UPS-1500 Series products is designed, qualified and screened according to SynQor's MIL-COTS Standards. It complies with the requirements of MIL-STD-704F, MIL-STD-1399-300B, MIL-STD-1275D and MIL-STD-461F, as well as IEC-EN61000 specifications for world-wide commercial utility applications.

The UPS-1500 Series products are designed and manufactured to withstand the harsh environments and use encountered in military applications. The electronic circuitry and battery are contained in a sealed chamber constructed from a die-cast aluminum chassis that is weather-proof and shock-proof. Redundant, water-proof fans on the rear panel draw cooling air over the heat-sink fins below the sealed chamber. Military-grade circular connectors are used, and optional attached connector covers are available for when the cables are not attached. The UPS-1500 Series products comply with a wide range of testing according to MIL-STD-810G.

The UPS-1500 Series is a 1U high rackmount unit, weighing 32 lbs. or 33.8 lbs. depending on the battery option selected. The battery options provide either >10 minutes, >13.5 minutes, or >16 minutes of battery run-time at full power.

The SynQor UPS-1500 Series products are designed and manufactured in the U.S.A.

Product Topology

The SynQor UPS-1500 Series products use a true on-line double conversion topology that provides protection to the load from spikes, noise, surges, brownouts, blackouts, etc. in the input power sources. This topology also provides smoothing of load transients and nonlinear load profiles so that the input power sources are not subjected to these type of disturbances. There is a seamless transfer from any power source to another so that there is no disruption in the output voltage waveform.

As the figure below shows, there is a nominal 28 V mid-bus within the UPS that draws power from one of up to three power sources: the 3-Phase AC INPUT (primary source), the optional DC INPUT (secondary source) or the battery (backup source). EMI filters are present at all external inputs and outputs.

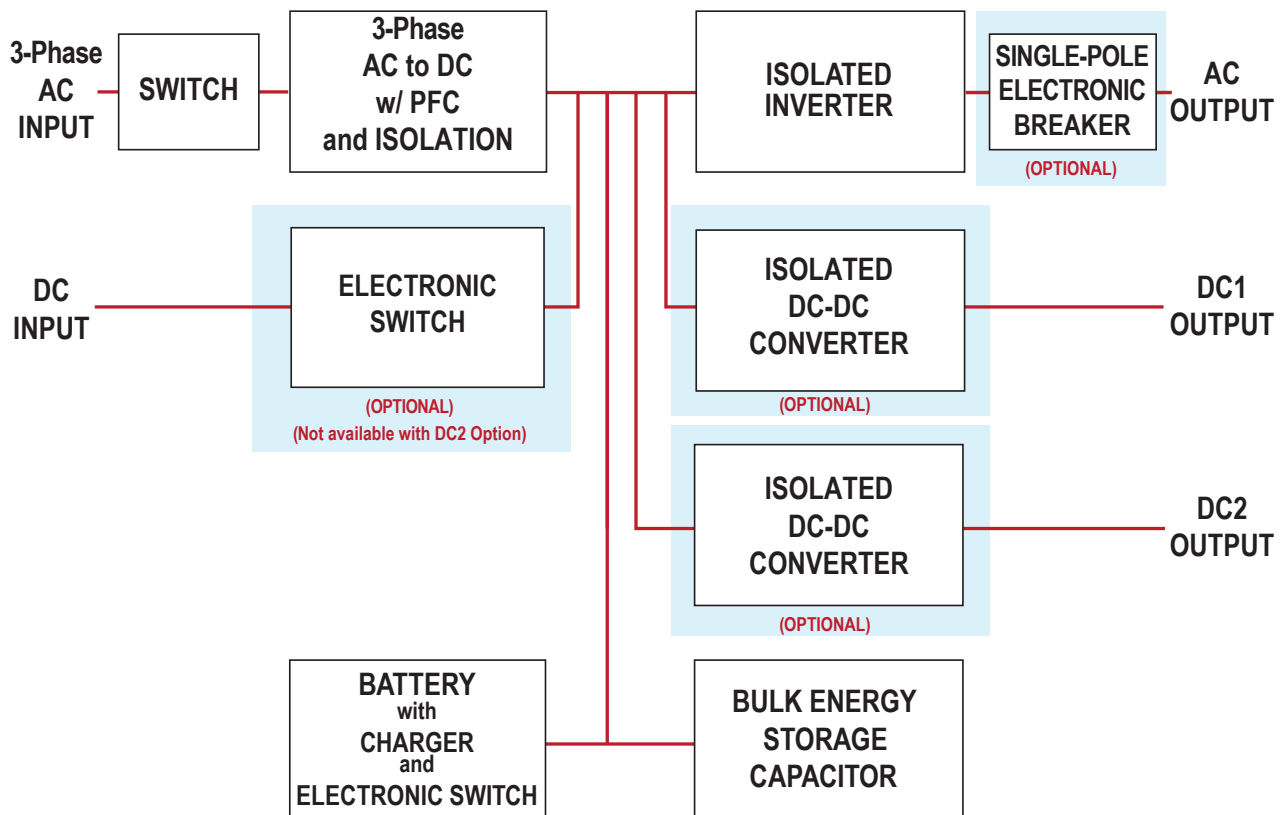

Power flows into the unit from the AC 3-Phase delta connected INPUT (no neutral wire connection) through a power switch. Internal fuses in the input protect the unit in the event of a hardware failure of the 3-Phase AC to DC INPUT stage. **Note: These fuses are not user serviceable.** The 3-Phase AC to DC INPUT stage provides input current limiting, Power Factor Correction (PFC), and high frequency isolation. In the DC INPUT power option, power flows from the DC INPUT through an electronic switch that is closed when the AC INPUT power is absent and the DC INPUT voltage is within valid range. If power is not available on the AC INPUT or in the optional DC INPUT, a second electronic switch is closed which interconnects the battery to the mid-bus.

The AC OUTPUT is created by an inverter that draws power directly from the mid-bus. This inverter provides high frequency safety isolation and a pure-sinusoidal output voltage waveform. An optional electronic breaker can be added to the AC OUTPUT. This one pole hot side only electronic breaker allows for fault tolerant, glitch free operation when several UPS units are placed in parallel. This option is referred as “expanded” parallel option.

Optional DC outputs at various voltage and power levels are also available. The DC1 option is limited to 500 W. The DC2 option can deliver up to 1250 W output. **NOTE: When the DC2 option is selected, the DC INPUT option is not available.** The DC1 and DC2 outputs are isolated from each other and from the AC OUTPUT.

Bulk energy storage capacitors are connected to the mid-bus to help smooth imbalances in power flow between the inputs and outputs of the UPS.

There is a battery charger circuit that draws power from the mid-bus. It ensures the batteries are normally fully charged and that the various cells are properly equalized. The battery also contains protection circuitry to avoid damage due to improper charging or discharging, or to excessive temperatures.

There is a communication/control port that provides a digital interface to a host computer system.



UPS in Transit Case Option

Part Numbering Scheme and Options

This table shows the part numbering scheme for the full line of SynQor UPS products:

Base Models				
Model Number	Power	Battery Run-Time @Full Power (80% Power)	Height (W x D x H)	Weight
UPS-1500-S-1U (1 Standard Battery Pack)	1250 W 1500 VA	>10 min. (>13 min.)	1U (17.00" x 21.60" x 1.73")	32 lbs.
UPS-1500-H-1U (1 Standard Battery Pack)	1250 W 1500 VA	>13.5 min. (>18 min.)	1U (17.00" x 21.60" x 1.73")	33.8 lbs.
UPS-1500-M-1U (1 Standard Battery Pack)	1250 W 1500 VA	>16 min. (>22 min.)	1U (17.00" x 21.60" x 1.73")	33.8 lbs.

Base Models	Options						
	AC Input Freq	AC Output Voltage	AC Output Neutral Wire	AC Output Set Point Freq	DC Input / DC2 Output	DC1 Output	Additional Options
UPS-1500-S-1U- UPS-1500-H-1U- UPS-1500-M-1U-	T	1 2	G F R	5 6 4	S D M P R V W	00 12 15 24 28 40 50	-E 00

Not all combinations make valid part numbers, please contact SynQor for availability. See the Product Summary web page for more options.

***Notes:**

Order "F: Floating" option when configuring the AC output for multi-unit combinations of up to 3 units.

Order "R: AC Output Electronic Breaker" option for fault-tolerant, glitch-free parallel systems of up to 32 units with N+M redundancy. The AC output neutral wire will not be connected to the chassis.

Examples:

UPS-1500-M-1U-L1G6D28-E00, UPS-1500-S-1U-L2G5S00-E00

Options	
AC Input Freq	T 3-Phase 45-800 Hz
AC Output Voltage	1 115 Vrms 2 230 Vrms
AC Output Neutral Wire	G Grounded F Floating* R AC Output Electronic Breaker*
AC Output Set Point Freq	5 50 Hz 6 60 Hz 4 400 Hz
DC Input / DC2 Output	S Not Installed D DC Input M DC2 Out 24 VDC with Droop Share P DC2 Out 24 VDC No Share R DC2 Out 28 VDC with Droop Share V DC2 Out 28 VDC No Share W DC2 Out 50 VDC No Share
DC1 Output	00 None 12 12 V 15 15 V 24 24 V 28 28 V 40 40 V 50 50 V
Additional Options	-E Ethernet/SNMP with Configuration Loading 00 No CE Marking

The UPS-1500 Series of products provide up to 1500 VA and 1250 W of total output power (AC plus DC). The UPS is a 1U high rackmount unit, weighing 32 lbs. or 33.8 lbs. depending on the battery option selected. The battery options provide either >10 minutes, >13.5 minutes, or >16 minutes of battery run-time at full power.

The UPS has various options that can be specified according to the part numbering scheme shown in the table:

- The allowable frequency of the AC INPUT can either be in the 47-65 Hz range (for 50 Hz and/or 60 Hz systems) or in the 360-800 Hz range (for 400 Hz and Variable Frequency systems)
- The output voltage of the UPS-1500 Series can be 115 VRMS or 230 VRMS
- The AC output can be configured with its neutral wire internally grounded to the chassis of the UPS or left floating for shipboard applications
- The Electronic Breaker option adds fault tolerant, glitch free operation multi-unit for N+1 or N+M redundancy. This option also allows up to 32 units total in Single Phase, Split Phase, or 3-Phase system.
- The initial set-point frequency of the AC OUTPUT voltage can be 50 Hz, 60 Hz or 400 Hz. Regardless of the initial set-point frequency, the actual frequency can be set through the communications/control port.
- There is an optional DC INPUT that is specified to comply with MIL-STD-704F and MIL-STD-1275D for 28 V systems.
- Two optional DC OUTPUT capabilities are available: DC1 with up to 500 W capability, and DC2 with up to 1250 W capability an optional droop share.
- RS232 serial port and logic-level I/O communication are included in the standard model. An Ethernet port providing web and SNMP interfaces is also included in the standard model.

Product Specifications

The following pages show the electrical and mechanical specifications of the UPS-1500-[S,H,M]-1U high Series of products. Data sheets showing these specifications and other information can be found at the web site <http://www.synqor.com/UPS>.

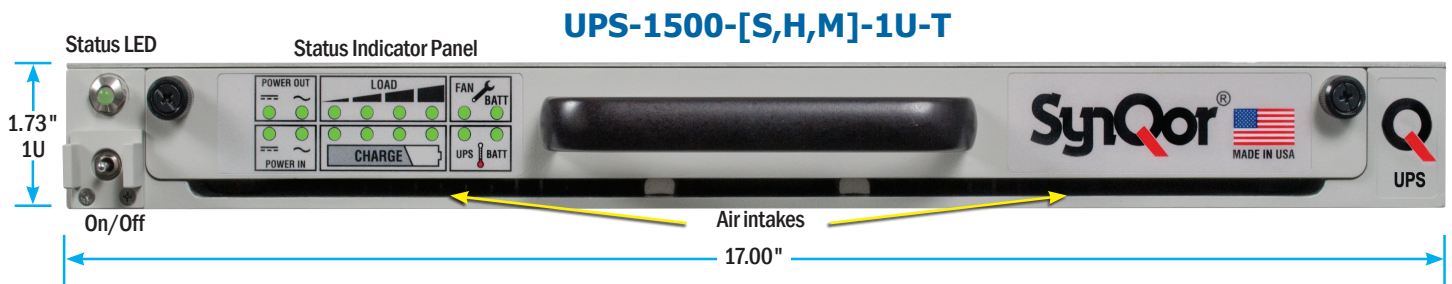

UPS-1500-[S,H,M]-1U-T with DC Input / DC1 Output Option

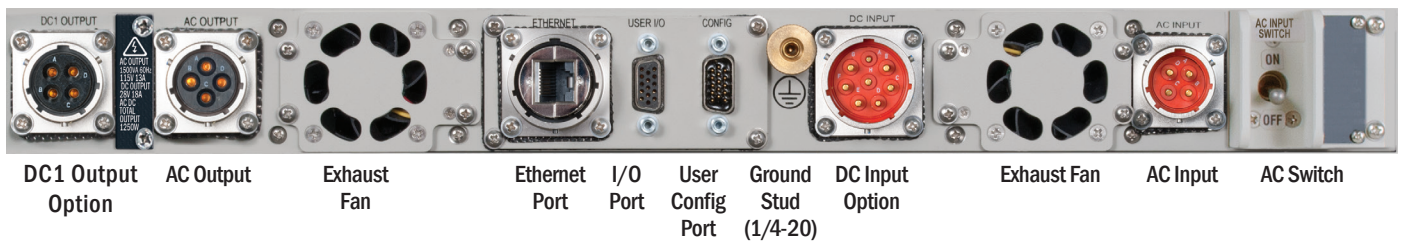

UPS-1500-[S,H,M]-1U-T with DC1 Output / DC2 Output Option

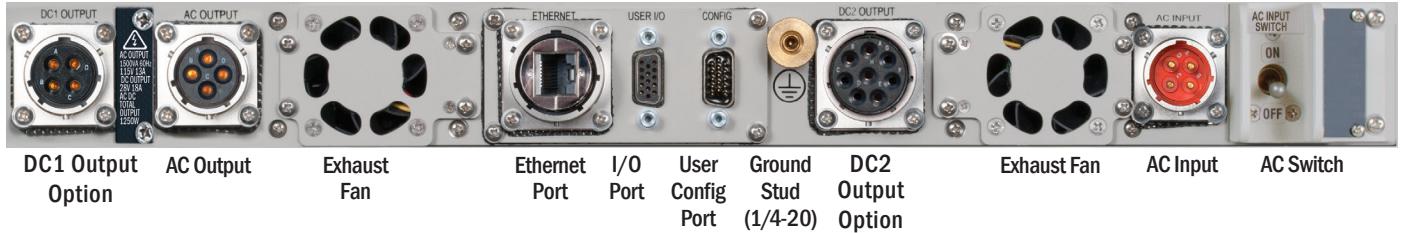

1U Mechanical Diagram

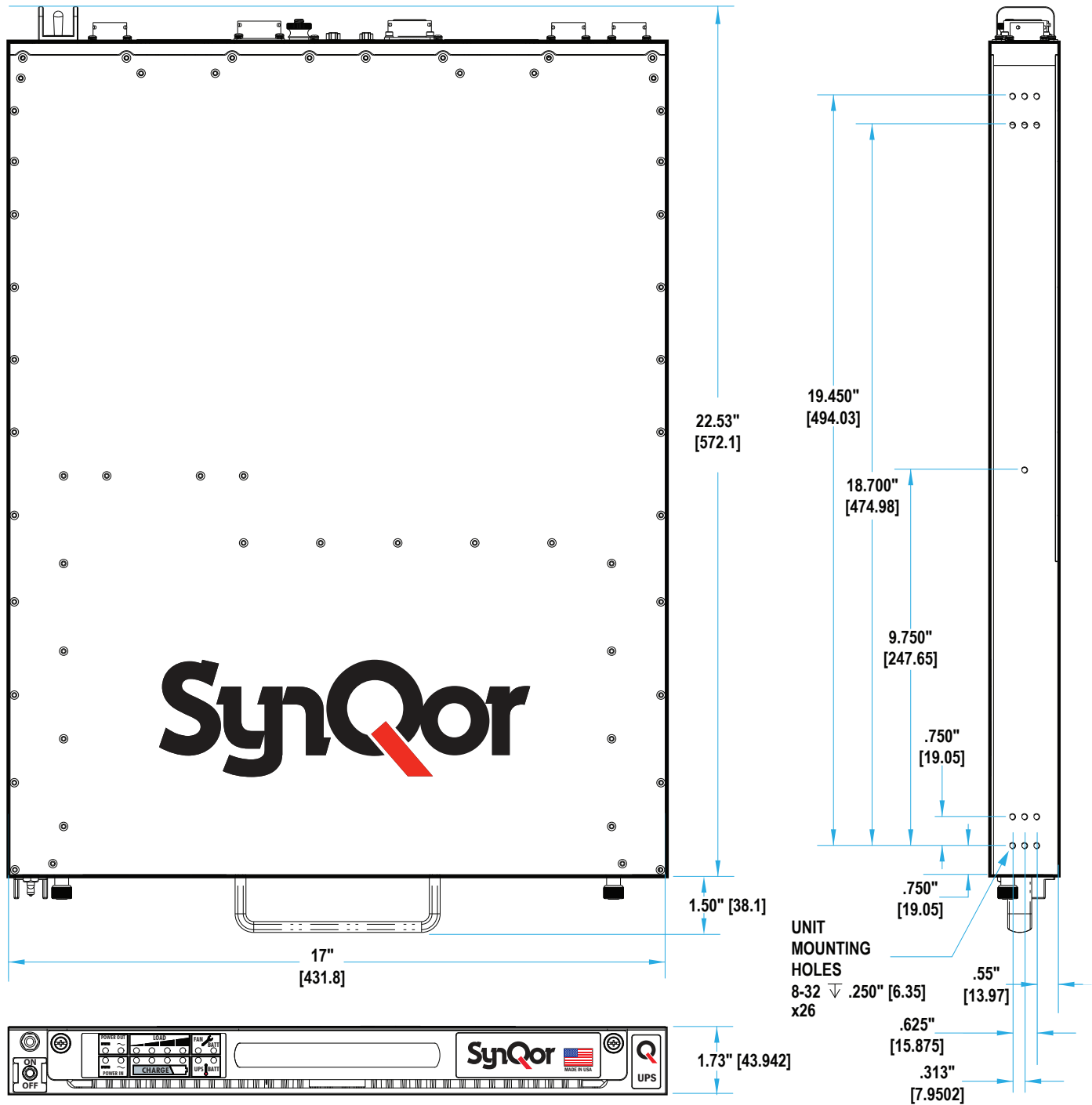

Electrical Characteristics

INPUT CHARACTERISTICS

Operating AC Input

Voltage	85 - 140 Vrms L-N* 147-242 Vrms L-L
3-Phase Connection Type	3-Wire Delta
Frequency	45-800 Hz
Input Power Factor	0.999 at 45-65 Hz 0.98 at 400 Hz
Maximum Input Current Continuous	8.3 A (full load, 85 Vrms L-N)
AC Input Fuse Rating	10 A

(* Power Derating to 85% below 100 Vrms L-N)

Operating DC Input (Optional)

Voltage	22-33 V
Continuous Maximum Input Current	62 A (full load, 22 V)
Transient Maximum Input Current	75 A

OUTPUT CHARACTERISTICS

Total Output Power Continuous	1250 W (1500 VA)
Maximum DC1 Output Power	510 W
Maximum DC2 Output Power	1250 W

(Note: Available AC power is reduced by power delivered to the DC output)

AC Output

AC Output Waveform	Pure Sinusoidal
Voltage	115 Vrms \pm 3% 230 Vrms \pm 3%
Frequency	60 Hz \pm 0.5% 50 Hz \pm 0.5% 400 Hz \pm 0.5%
Peak Load Current	26 A (115 Vrms) 13 A (230 Vrms)
Load Power Factor	0-1.0 (leading or lagging)
Total Harmonic Distortion	2% (1000 W resistive load)

DC1 Output (optional)

Voltage Regulation (Over Load & Temperature)	\pm 3%
Common Voltage/Power combinations (DC1) (Other Options Available)	12V at 42 A =504 W 15V at 34 A =510 W 24V at 21 A =504 W 28V at 18 A =504 W 40V at 12.5 A =500 W 50V at 10 A =500 W

DC2 Output (optional)

Voltage Setpoint	\pm 3%
No Sharing	
Voltage Regulation (Over Load & Temperature)	-2%
Common Voltage/Power combinations (DC2)	24V at 50 A =1200 W 28V at 44.6 A =1250 W 50 V at 20 A =1000 W

Droop Share (Output droops vs. load to allow passive sharing among modules.)

24V Option

Voltage Regulation (Over Load & Temperature)	-15%
	26V at 0 A 22V at 50 A =1100 W

28V Option

Voltage Regulation (Over Load & Temperature)	-13%
	30V at 0 A 26V at 48.1 A =1250 W

ENVIRONMENTAL CHARACTERISTICS MIL-STD-810G

Temperature Methods 501.5, 502.5

Operating Temperature	-20 °C — +55 °C
Storage Temperature	-40 °C — +65 °C

Altitude Method 500.5

Operating	0 - 18,000 ft
Non-operating	0 - 40,000 ft

Environmental Tests

Shock/Drop	Method 516.6, Procedures 1,4,6
Temperature Shock	Method 503.5, Procedure 1
Vibration	Method 514.6, CAT 5, 7, 8, 9, 24
Fungus	Method 508.6
Salt Fog	Method 509.5
Sand and Dust	Method 510.5, Procedures 1,2
Rain	Method 506.5, Procedure 1
Humidity	Method 507.5, Procedure 2
Mechanical Vibrations of Shipboard Equipment	Method 528, Procedure 1

RELIABILITY CHARACTERISTICS MIL-HDBK-217F

MTBF	100 kHrs	MIL-217F Ground Benign, Ta=25 °C
------	----------	----------------------------------

ELECTROMAGNETIC CAPABILITY MIL-STD-461F

CE101	30 Hz - 10 kHz
CE102	10 kHz - 10 MHz
CS101	30 Hz - 150 kHz
CS106	10 kHz - 40 GHz
CS114	10 kHz - 200 MHz
CS116	10 kHz - 100 MHz
RE101	30 Hz - 100 kHz
RE102	10 kHz - 18 GHz
RS101	30 Hz - 100 kHz
RS103	2 MHz - 40 GHz

MECHANICAL CHARACTERISTICS

1U (Standard Battery Pack)

Chassis Size (H x W x D)	17.00"W x 22.53"D x 1.73"(1U)
Case Material	Aluminum
Total Weight	32 lbs. (with chassis & battery)

Connectors

AC Input Connector	MS3470L14-4PW
DC Input Connector	MS3470L18-8P
AC Output Connector	MS3470L14-4S
DC1 Output Connector	MS3470L14-4SW
DC2 Output Connector	MS3470L18-8S
User I/O Ports	HD DB15 Female
Configuration I/O Port	HD DB15 Male
Ethernet Port	Amphenol RJF22N00, Code B

Cooling Exhaust Fans

Sound Pressure Level (SPL)	54 dB(A)
Air Flow	0.67(m ³ /min) 23.7 CFM

Two fans in system, above specs are for each fan separately.

UPS Efficiency

Figure 1 shows the typical efficiency with which the UPS-1500 3-Phase series uninterruptible power supplies delivers power to its AC OUTPUT from a 200 Vrms_{L-L}/115 Vrms_{L-VN} AC INPUT or a 28 V DC INPUT. The insertion loss of the “Electronic Breaker” option can be of up to 1% of the total efficiency at full load.

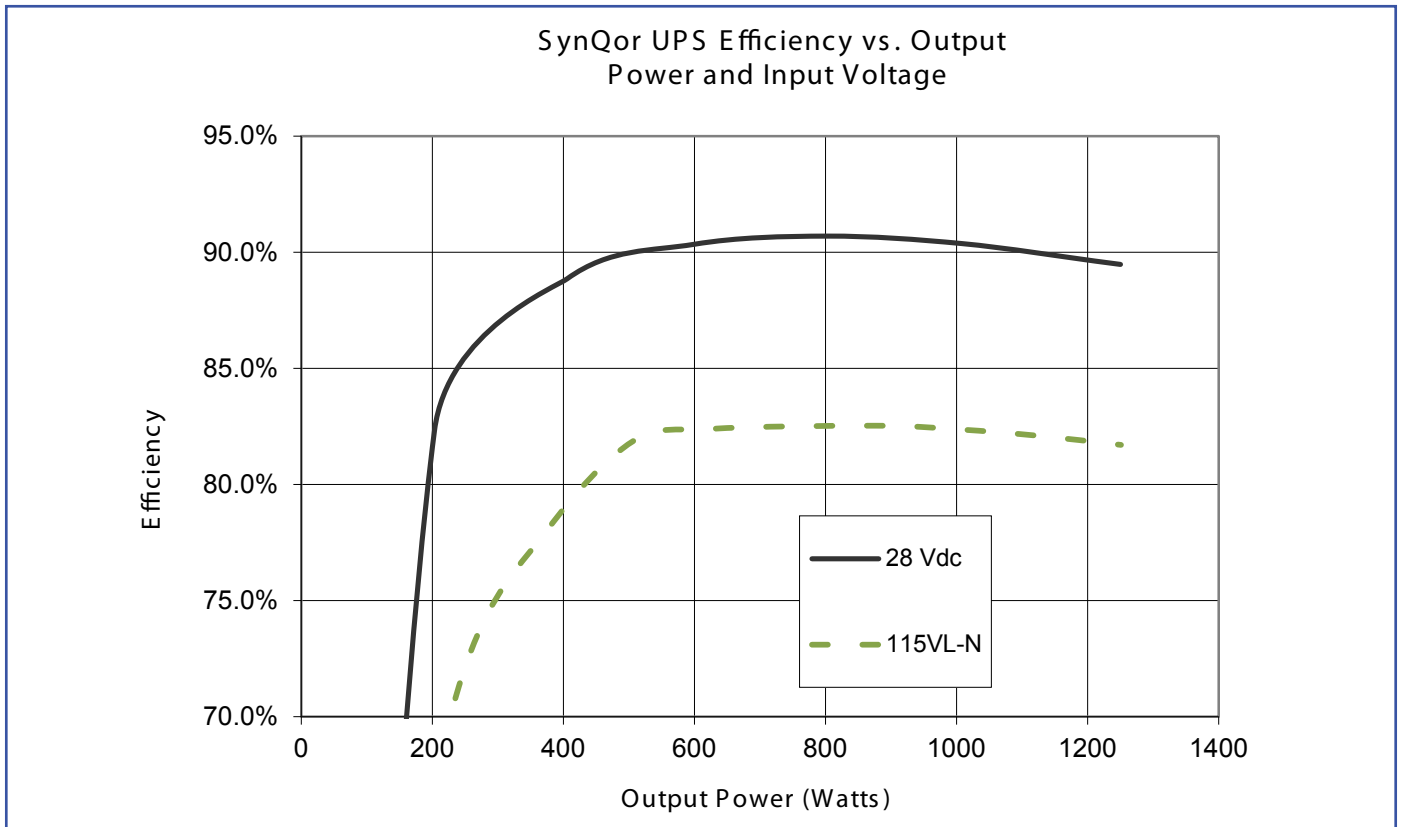

Figure 1

Total Output Power that can be derived from the AC INPUT

The total combined UPS output power (the AC OUTPUT power plus the optional DC OUTPUT power options) for the UPS-1500 series is rated at 1250 W for an ambient temperature as high as 55 °C (131 °F). Power is drawn first from the primary AC INPUT (if voltage is within range) and then the secondary DC INPUT (if voltage is within range) and then from the internal BATTERY PACK (if it has sufficient charge).

However, when the AC INPUT voltage is at the low end of its range ($<100V_{L-N}$ AC) the UPS will not be able to deliver its full rated output power in the steady-state without switching over to either the DC INPUT (if it is available and >22 Vdc) or its internal battery. If one of the phases is missing in the 3-Phase AC INPUT source the UPS will switch to the secondary DC INPUT source if present, or the to the battery backup if the DC INPUT source is not available.

Figure 2 indicates the total steady-state output power that the UPS can draw from the AC INPUT vs line voltage. See Figure 3 for information on transient conditions.

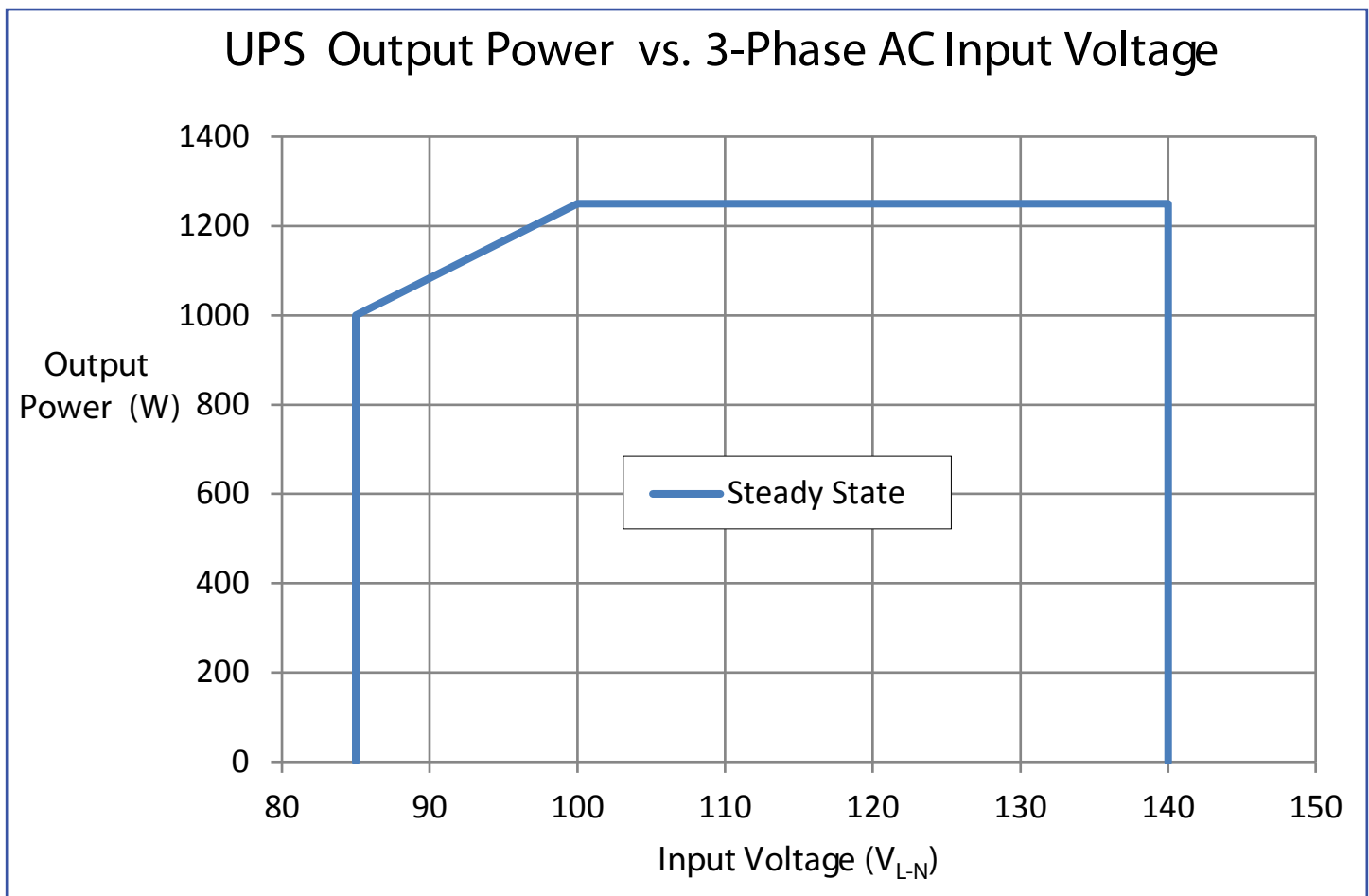

Figure 2

- If the AC INPUT voltage is above $100 V_{L-VN}$, then the UPS can deliver its full rated output power of 1250 W from the AC INPUT for an ambient temperature as high as 55°C (131°F) without needing to switch over to the optional DC INPUT or the internal BATTERY PACK
- If the AC INPUT is between $100 V_{L-VN}$ and $85 V_{L-VN}$ then the total output power that can be derived from the AC INPUT linearly decreases from 1250 W at $100 V_{L-VN}$ to 1000 W at $85 V_{L-VN}$. For example, the total output power that could be drawn from the AC INPUT would be 1083 W at $90 V_{L-VN}$. If the total output power is greater than this derated value, the UPS will switch to the DC INPUT (if it is available and $>22\text{ V}$) or the internal BATTERY PACK.

Power Cable Wiring Diagram

Looking at the rear panel, the UPS connector terminals have the following functions and locations:

AC INPUT	
Pin	Function
A	Line 1
B	Line 2
C	Line 3
D	Ground

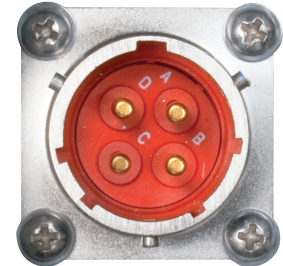
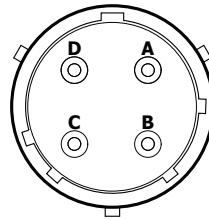

DC INPUT	
Pin	Function
G, F, E	+V _{IN}
B, C, D	V _{IN} Return
A, H	No Connect

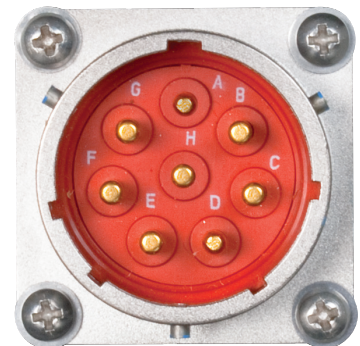
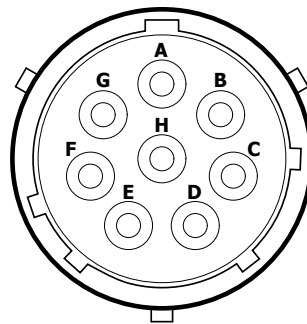

AC OUTPUT	
Pin	Function
A	Line
B	Neutral
C	No Connect
D	Ground

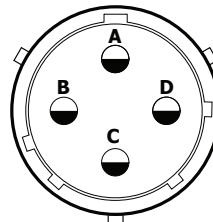

DC1 OUTPUT	
Pin	Function
C, D	+V _{OUT}
A, B	V _{OUT} Return

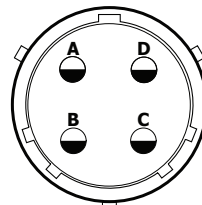

DC2 OUTPUT	
Pin	Function
G, F, E	+V _{OUT}
B, C, D	V _{OUT} Return
A, H	No Connect

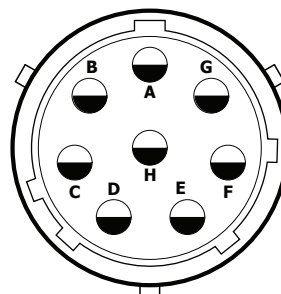

Power Cable Wire Size

SynQor recommends the following cables for use with the UPS-1500 Series:

AC INPUT:	SYN-9114	UPS connection to NEMA L15-30P Plug, 10'
	SYN-9113	UPS connection to Hardwire Termination, 10'
AC OUTPUT:	SYN-9131	UPS connection to NEMA 5-20 Receptacle, 10'
	SYN-9130	UPS connection to Hardwire Termination, 10'
DC INPUT:	SYN-9151	UPS connection to Ring Connectors, 10'
	SYN-9154	UPS connection to NATO Connector, 10'
DC1 OUTPUT:	SYN-9171	UPS connection to Fork Connectors, 10'
	SYN-9172	UPS connection to Hardwire Termination, 10'
DC2 OUTPUT:	SYN-9174	UPS connection to Hardwire Termination, DC2 OUTPUT, 10'
	SYN-9175	UPS connection to Fork Connectors, DC2 OUTPUT, 10'

Other options may be available. Contact info@synqor.com or visit the website: <http://www.synqor.com> for more information. If it is necessary to develop custom cables for your application, please read through the following section for some important considerations. **Note: Damage caused by improper wiring of cables will not be covered under SynQor's warranty.**

Both the input and output cables of the UPS carry substantial current, and since the wires in these cables have resistance, the current flowing through them causes a voltage drop from one end of the cable to the other. In other words, the voltage across the cable at its downstream end is smaller than the voltage across the cable at its upstream end. Mathematically, the amount that the voltage drops is equal to the resistance of the cable's wire multiplied by the current flowing through the wire. It is therefore important to make sure that the resistance of the cable's wire is small enough to keep this voltage drop to an acceptable level.

While this is an issue for all of the power cables, it is particularly important for the DC INPUT and DC2 OUTPUT cables. DC current flowing through these cables can be very high (65 A for the UPS-1500 Series) while at the same time, the input voltage to the UPS is relatively small (22 V). A common problem might develop due to high cable resistance (when the DC INPUT cable gage is too small) which causes the input voltage to the UPS to fall below the 22 V minimum. Under this condition the UPS will switch to the internal battery pack for its power source even though the voltage at the DC power source appears to be available and within proper range.

The resistance of a wire is also directly proportional on its length. A wire twice as long as another will have twice the resistance, holding all other things constant. The resistance in a cable is also inversely proportional to the cross-sectional area of the wire, which in turn is proportional to the square of the diameter of the cable. A wire with half the diameter of another will therefore have four times the resistance, holding all other things constant.

Therefore, the longer a cable is, the more important it is that the wire's diameter be large. Alternatively, a cable can have multiple pairs of wires to achieve a larger "effective wire diameter". This second approach gives a more flexible cable. For 10 ft long cables, SynQor recommends that for the UPS-1500 Series:

- The AC INPUT cable have 3 wires (one for the ground) of 12 AWG
- The DC INPUT cable have 6 wires (three for each DC pole connection) of 12 AWG
- The AC OUTPUT cable have 3 wires (one for ground) of 12 AWG
- The DC1 OUTPUT cable have 4 wires (two for each DC Pole connection) of 12 AWG
- The DC2 OUTPUT cable have 6 wires (three for each DC Pole connection) of 12 AWG

Additional details about the effects of a resistance-related voltage drop are included in "Trouble-Shooting Guide - Cable wire resistance is too high".

Set-Up

The following are the recommended installation steps for the 3-Phase UPS-1500 series:

- Insert the BATTERY PACK (if not already present) and tighten its screws.
- Make sure the AC SWITCH on the rear panel of the UPS is in the “OFF” position.
- Connect the ground wire to the ground stud on the rear panel of the UPS.
- Connect all OUTPUT cables, first to the UPS and then to the various loads.
- **VERIFY** that the optional DC OUTPUT cable is connected to the UPS and the load is connected with the correct polarity.
- Connect the USER I/O cables.
- Connect the 3-Phase INPUT AC cables, first to the UPS and then to the source.
- Connect the DC INPUT cables (if the option is available), first to the UPS and then to the source.
- An overcurrent protect and disconnect device should be installed on the DC INPUT circuit. An example of a suitable device is a Carling Technologies, C-series, 80 A 65 VDC, CA1-B0-14-680-321-J circuit breaker. (www.carlingtech.com)
- **VERIFY** that the optional DC INPUT cable is connected to the UPS and the source of DC power with the correct polarity.
- Turn “ON” both the AC and DC (if present) sources.
- Move the AC SWITCH on the rear panel of the UPS to the “ON” position.

Note: Be careful to not toggle the “ON/OFF” switch during the setup. Doing so could cause the UPS to turn “ON” and have a hazardous voltage at the output.

Start-Up

- **VERIFY** that all connections to the UPS are correct.
- Verify that either the 3-Phase AC source or the DC source (or both) are present and within range. If the AC INPUT source or the DC source are active and within range, the color of the LED above the “ON/OFF” switch will be amber. The amber light indicates that the UPS is in standby mode and ready to be turn “ON”. The battery pack LEDs will also be appropriately illuminated.
- Momentarily push the “ON/OFF” switch on the front panel of the UPS upward. The switch can then be released and it will return to its normal (neutral) position.
- The UPS will immediately enable its outputs (assuming there is no fault condition). The color of the LED above the “ON/OFF” switch will switch from amber to green. The LEDs on the battery pack will indicate the amount of power being delivered to the load. LEDs on the front panel will also indicate which source is currently in use.

Note: If no input power sources are available or within the required range, the UPS can still be turned “ON”. The UPS will draw power from the internal battery for as long as the battery has charge. A battery startup procedure is also referred as a “COLD START” in the industry. If no input source is available other than the battery pack, the LEDs above the “ON/OFF” switch and the battery pack LEDs will be initially “OFF”. When the “ON/OFF” switch is pushed to the “ON” position, all of these LEDs will be appropriately illuminated.

Shut-Down

- Shut down the equipment connected to the UPS.
- Push the “ON/OFF” switch on the front panel of the UPS downward and hold it in this position for more than 1 second. The color of the LED above the “ON/OFF” switch will switch from green to amber (if one or both input power sources are present) or it will turn “OFF” (if no power sources are present). The switch can then be released to return to its normal position.
- The UPS will disable all outputs and proceed to shut down.
- The battery pack LEDs will either be appropriately illuminated (if one or both input power sources are present) or they will be “OFF” (if no power sources are present).
- It is not necessary to move the AC SWITCH on the rear panel of the UPS to the “OFF” position.

Power Cable Connections/Disconnections While Operating

For safety reasons, it is highly recommended that the input and output power cables be connected to the UPS before the source of AC or DC INPUT power is turned “ON”, and before the UPS is turned “ON” (see **Section I: Warnings** and the **SET-UP** section above). Similarly, it is **highly recommended** to first turn “OFF” the UPS and any active input sources before any power cables are disconnected from the UPS.

However, the SynQor UPS is capable of having any of its input or output power cables connected at any time (if safely done), including while the UPS is turned “ON” and delivering power to the load. For instance:

- Even if the UPS is turned “ON”, one can connect or disconnect the input power cables without harming the UPS or disrupting power delivery to the load. If no INPUT power source is available, the UPS will draw power from the battery pack. When there is an external source of power connected to the UPS, the unit will draw power from that source. The UPS will always select as its primary power source the AC INPUT, if present and if all phases are within range. The DC INPUT source will be selected as an input source only, if no AC INPUT is present or if the AC INPUT is not within input specifications. Switching INPUT source from AC, to DC to battery is carried out seamlessly and glitch free by the UPS internal control system.
- Even if the UPS is turned “ON”, one can connect or disconnect an output power cable without harming the UPS or disrupting power delivery to a load that might be connected in one of the other output connectors.

NOTE that disconnecting an input or output power cable while that cable is handling power will likely cause an arc to form as the terminals are pulled apart. This arcing is not harmful to the UPS, although if done enough times it will degrade the connector to the point where it will need to be replaced. This problem is particularly acute for the **DC INPUT cable because of its high current. Disconnecting this cable while a large current is flowing is not recommended.**

ALSO NOTE that when the UPS is turned “ON” and delivering power to a load, and then another piece of equipment is connected to the same output, it is possible that this connection will momentarily disrupt the quality of the UPS’s output voltage. For instance, consider the case where the AC OUTPUT power cable has a terminal strip that allows several loads to be connected. If the UPS is turned “ON” and delivering power to several loads, and another load is turned “ON”, it is possible that the new load will momentarily draw a large surge of current at startup. If this happens, the output of the UPS could momentarily reach its maximum current limit, which will cause the UPS to reduce its output voltage to keep the current from getting any larger. The reduction in voltage will be corrected once the new load reaches normal operation. However, in the meantime the reduction of the UPS’s output voltage might cause one or more loads to malfunction. Whether or not this will be a problem depends on the characteristics of each of the various loads.

Cooling System

The SynQor UPS-1500 Series products are cooled by fans that draw air into the intake below the battery pack on the front panel and exhaust through two fan ports on the rear panel. Care should be taken to ensure there is no airflow obstruction, either at the front air-intake or the rear exhaust. Care should also be taken to avoid obstructing the fan blades.

The speed of the cooling fans is automatically controlled by the UPS internal control to provide adequate cooling while extending the life of the fan bearings. Under low ambient temperatures and/or low UPS output power the fans will be driven at a low speed. If the ambient temperature and output power are such that the UPS cannot otherwise maintain its specified maximum temperature for its internal circuitry, the fans will momentarily be driven at a speed that exceeds their rated long-term running speed. There is a LED on the front panel of the battery pack that indicates the speed of the fans.

If the ambient temperature is low enough (for the level of power being delivered to the load), the fans may not be “ON”. This is not a malfunction. It is done to preserve the life of the fans. If the fans are “OFF”, check the Fan Service Required LED on the front panel of the battery pack. If the LED is GREEN, the fans are functioning properly and simply are not needed under the present conditions.

The fans are weather-proof and water-proof.

The UPS has two fans to provide redundancy for these exposed, moving components. With only a single operating fan the UPS is still able to deliver 100% rated power at an ambient temperature as high as 40°C, and it is able to deliver 80% of its rated power at an ambient temperature as high as 55°C.





Front Panel Indicators

To indicate the status of the UPS and its battery pack, there is one LED above the “ON/OFF” switch on the left side of the front panel of the UPS and an additional 16 LEDs on the front panel of the battery pack. There is also an audible alarm. These indicators are described in this section.

LEDs

LED above the “ON/OFF” switch

This LED has four possible indications, according to the table below:

LED Appearance	Description	Indication
	Green	UPS is Running <i>(Outputs are Enabled)</i>
	Amber	UPS is on Standby <i>(Outputs are Enabled)</i>
	Red	UPS has a Fault Condition
	OFF	UPS is “OFF”



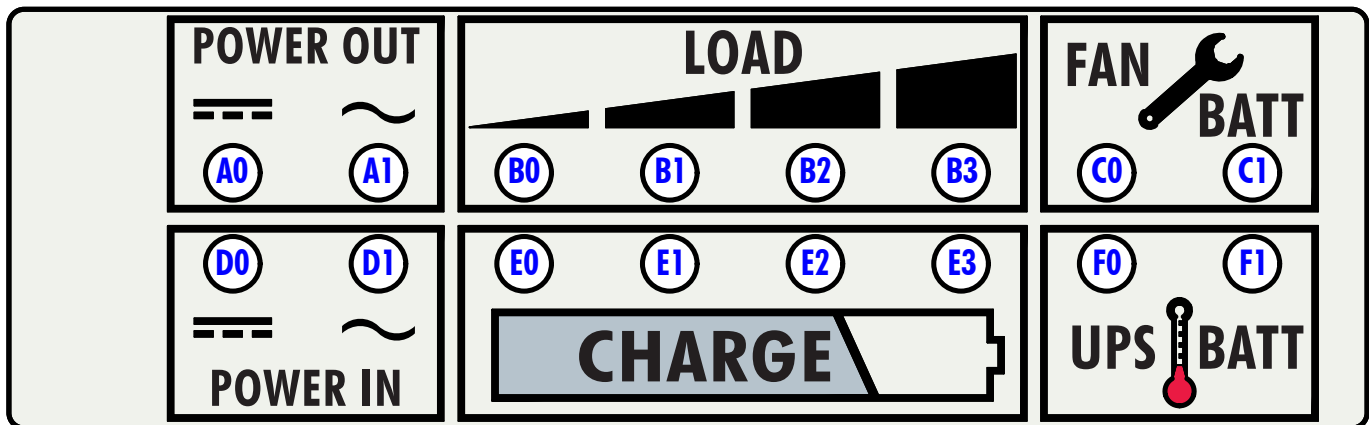

LEDs on the Battery Pack

Each battery pack has 16 LEDs, as shown below, that indicated the status of the battery pack and of the operation of the UPS:







Power-In Indicators (LEDs in positions D0 and D1)

The LED in position D0 indicates the status of the optional DC INPUT and the LED in position D1 indicates the status of the AC INPUT, according to the table below:

LED Appearance	Description	Indication
	Green	<i>Input is Ready to Provide Load Power</i>
	Pulsing Green	<i>Input is the One Presently Selected as the Source of Power</i>
	Amber	<i>Input has Returned within Range and Diagnostic Tests are Being Performed</i>
	OFF	<i>Input is Not within Range (Or the DC INPUT Option is not Installed)</i>

Power-Out Indicators (LEDs in positions A0 and A1)

The LED in position A0 indicates the status of the optional DC OUTPUT and the LED in position A1 indicates the status of the AC OUTPUT, according to the table below:

LED Appearance	Description	Indication
	Green	<i>UPS is "ON" and the Output Voltage is Within Range</i>
	Amber	<i>UPS is "ON" but the Output Voltage is Out of Range</i>
	Red	<i>UPS is "OFF" and the Output Voltage is Within Range</i>
	OFF	<i>UPS is "OFF" (Or the DC Output Option is not Installed)</i>

Load Power Indicators (LEDs in positions B0 – B3)

The LEDs in positions B0 through B3 indicate the total output power of the UPS (The AC OUTPUT power plus the optional DC OUTPUT power) according to the table below:

LED Appearance	Description	Indication
	B0 Dimmed Green; B1, B2, B3 "OFF"	Total Load Power <25%
	B0 Green; B1 Dimmed Green; B2, B3 "OFF"	Total Load Power <50%
	B0, B1 Green; B2 Dimmed Green; B3 "OFF"	Total Load Power <75%
	B0, B1, B2 Green; B3 Dimmed Green	Total Load Power <100%
	B0, B1, B2 Green; B3 Blinking Red	Total Load Power ≥100%





Battery State-of-Charge Indicators (LEDs in positions E0 – E3)

The LEDs in positions E0 through E3 indicate the state-of-charge of the internal battery pack, as well as whether the battery pack is on standby or being charged (**Blinking Amber**) or discharged (**Blinking Red**), according to the table below.

LED Appearance			Indication
Standby	Discharging	Charging	
	NA	NA	Battery Charge <10%
			Battery Charge <25%
			Battery Charge >25%
			Battery Charge >50%
			Battery Charge >75%
	NA	NA	Battery Charge =100%
	NA	NA	Battery Charge =100% (Cell Balancing is Occurring)





UPS Cooling System Indicator (LED in position F0)

The LED in position F0 indicates the temperature and status of the cooling system for the UPS according to the table below:

LED Appearance	Description	Indication
	Green	<i>Moderate UPS Temperature (Fans Running at 33%)</i>
	Blinking Green	<i>Warm UPS Temperature (Fans Running at 67%)</i>
	Amber	<i>Elevated UPS Temperature (Fans Running at 100%)</i>
	Red	<i>Maximum UPS Temperature (Fans Running at 110%)</i>



Battery Pack Temperature Indicator (LED in position F1)

The LED in position F1 indicates the temperature of the battery pack (and its availability to be charged or discharged because of its temperature) according to the table below:

LED Appearance	Description	Indication
	Blinking Red	<i>Battery is too Cold to be Charged or Discharged</i>
	Blinking Amber	<i>Battery is too Cold to be Charged</i>
	Green	<i>Battery Temperature is Within its Specified Operating Range</i>
	Amber	<i>Battery is too Hot to be Charged</i>
	Red	<i>Battery is too Hot to be Charged or Discharged</i>



Fan Service Required Indicator (LED in position C0)

The LED in position C0 indicates whether the two cooling fans in the rear panel of the UPS are OK or if their performance is degraded, according to the table below:

LED Appearance	Description	Indication
	Green	<i>Both Fans are "OK"</i>
	Amber	<i>One or Both Fans Have Recently Had Degraded Performance and Diagnostic Tests are Being Performed</i>
	Red	<i>One or Both Fans Presently Have Degraded Performance</i>

Battery Pack Service Required Indicator (LED in position C1)

The LED in position C1 indicates whether the battery pack is OK or if its storage capacity has been degraded compared to its rated value, according to the table below:

LED Appearance	Description	Indication
	Green	<i>Battery Pack is "OK"</i>
	Amber	<i>Battery Pack's Calculated Maximum Storage Capacity is <75% of its Rated Value</i>
	Red	<i>Battery Pack's Calculated Maximum Storage Capacity is <50% of its Rated Value</i>

Audible alarm

For critical situations a pattern of audible tones will be repeated every 5 seconds. The table below describes each audible alarm pattern. The audible alarms can be silenced by holding the “ON/OFF” switch on the front panel in the “UP” position until a chirp is heard. A new alarm condition will cause the audible alarm to be reactivated. Contact Factory for instructions on how to permanently silence the alarm.

Number of Tones in Pattern	Indication
One	<i>UPS is Drawing Power From the Battery Pack</i>
Two	<i>Load Power is greater than or approaching 100% Rated Power</i>
Three	<i>Fault Appears on the AC Output UPS Must be Turned “OFF” and Back “ON” to Reset Fault</i>
Four	<i>UPS is Drawing Power From the Battery Pack and the Remaining Charge is <10%</i>

Hot Swapping the Battery Pack

The battery pack can be removed or inserted into the UPS without disrupting the delivery of power to the load, as long as a viable input power source is available. This feature is referred as “hot swapping” in the industry. It can be used to replace a battery pack that needs servicing, or to replace a drained battery pack with a, fully charged spare. Replacing a depleted battery pack with a charged battery pack spare, might be required if back-up protection is necessary and the current battery pack has had no chance to recharge.

Note: if no viable input power source is available for the UPS and the UPS is actively running of the battery backup, the removal of the battery pack would cause the UPS’s to shut down and stop supplying power to the load.

Operating Environment

The SynQor UPS-1500 Series is designed for the extreme environmental conditions of military and aerospace applications. All the electronic circuitry and the battery pack are contained in a sealed, weather-proof, shock-proof chamber constructed of die-cast aluminum. Only the redundant, water-proof cooling fans are exposed to the environment. Protection circuitry ensures that the battery is not charged or discharged if it is too hot or too cold. The UPS will shut down if it is too hot.

The UPS (equipped with connected cables or installed connector covers and an installed battery pack) has been qualified to the following MIL-STD-810G requirements:

MIL-STD-810G Test Method	Name	Procedure	Details
500.5	Low Pressure	I, II and III	<ul style="list-style-type: none"> ▪ 15,000 ft. operating ▪ 40,000 ft. storage
501.5	High Temperature	I and II	<ul style="list-style-type: none"> ▪ +55 °C operating ▪ +65 °C storage
502.5	Low Temperature	I and II	<ul style="list-style-type: none"> ▪ -20 °C operating ▪ -40 °C storage
503.5	Temperature Shock	I	<ul style="list-style-type: none"> ▪ 10 cycles; >10 °C/minute
506.5	Rain	I	<ul style="list-style-type: none"> ▪ 4" rain/hour ▪ 40 mph wind velocity
507.5	Humidity	NA	<ul style="list-style-type: none"> ▪ >95%
508.6	Fungus	NA	<ul style="list-style-type: none"> ▪ 28 day test
509.5	Salt Fog	NA	<ul style="list-style-type: none"> ▪ 5% salt solution ▪ 2 cycles (24 hr wet/24 hr dry)
510.5	Sand and Dust	I and II	<ul style="list-style-type: none"> ▪ 20 mph blowing dust ▪ 40 mph blowing sand
514.6	Vibration	Category 5	<ul style="list-style-type: none"> ▪ 5 Hz (300 RPM) ▪ Loose Cargo
514.6	Vibration	Category 7	<ul style="list-style-type: none"> ▪ General Exposure
514.6	Vibration	Category 8	<ul style="list-style-type: none"> ▪ C-130 Aircraft level
514.6	Vibration	Category 9	<ul style="list-style-type: none"> ▪ General Exposure
514.6	Vibration	Category 24	<ul style="list-style-type: none"> ▪ PSD = 0.04 g²/Hz; 20-2000 Hz ▪ Operating
516.6	Shock	I, IV and VI	<ul style="list-style-type: none"> ▪ 20 g/20 ms; 40 g/11 ms; 75 g/6 ms ▪ 48 inch drop in transit case ▪ 30 degree tilt and drop
528	Mechanical Vibrations of Shipboard Equipment	I	<ul style="list-style-type: none"> ▪ Operating

General Considerations

The UPS supports two different paralleling schemes for load sharing applications: “standard” paralleling and “expanded” paralleling. With standard paralleling, up to three UPS units can be combined to function as a single system. A fault on any one unit will cause the entire system to shut down. With expanded paralleling, up to 32 UPS units can be combined in a multi-unit system to form high power Single-Phase, Split-Phase and 3-Phase configurations. The expanded paralleling option includes an electronic breaker on the hot AC OUTPUT wire which provides fault-tolerant, glitch-free operation should one UPS unit fail. The expanded paralleling option allows users to add extra UPS units to a multi-unit system for N+1 redundancy, or more generally N+M redundancy.

Standard vs. expanded paralleling is determined by the “AC OUTPUT Neutral Wire” option in the UPS part number. See the table below.

Note: standard paralleling units cannot be mixed with redundant parallel units in multi-unit systems.

Ordering Information: Standard Vs Redundant Parallel		
	AC OUTPUT Neutral Wire option	Example PN
Single Unit (no paralleling)	-G	UPS-1500-S-1U-T1GS00-ECE
Standard Parallel	-F	UPS-1500-S-1U-T1FS00-ECE
Expanded Parallel	-R	UPS-1500-S-1U-T2RS00-ECE

Note: When combining UPS units into the configurations described in this section, each UPS must internally have the neutral wire of its AC OUTPUT floating, rather than connected to its chassis. This requires that all the UPS units have the “F” option for standard parallel units and “R” option for expanded parallel units regarding the AC OUTPUT neutral wire connection. Check the UPS part numbers to be sure this is the case before ordering units to implement systems described in this section.

Standard Paralleling “F” Option

With standard paralleling, up to three SynQor UPS units with identical “F” type model numbers can be combined in various ways to achieve:

- Higher output power
- Higher output voltage
- Multiple output phases

A configuration-specific CONFIGURATION cable determines each UPS unit’s role in a standard parallel system. These CONFIGURATION cables are available from SynQor, and the proper part number for any configuration is given in the following pages. These **CONFIGURATION** cables are unique to “F” option paralleling and cannot be used with “R” option UPS units.

Configuration-specific OUTPUT and/or INPUT power cables are also required. These power cables can be assembled by the user following the wiring diagrams shown below, or they can be ordered from SynQor using the proper part number given in the pages that follow.

In a standard parallel system, the AC OUTPUT will remain “OFF” until all UPS units are enabled. Each unit must be enabled by actuating the front panel switch “ON”, or by sending the appropriate signal over the USER I/O cable. If any UPS unit is “OFF”, all of the UPS units will disable their outputs. If any UPS unit cannot deliver output power because it cannot draw power from its AC INPUT, its DC INPUT or its BATTERY, or due to an internal fault, then all of the UPS units in the system will disable their outputs.

Expanded Paralleling “R” Option

The extended paralleling “R” option adds an electronic breaker to the AC OUTPUT of the UPS to provide fault-tolerant, glitch-free parallel operation. Should one unit experience a fault that could otherwise cause the AC OUTPUT to collapse, the breaker disconnects the failed unit from the AC bus. This configuration allows the remaining units to continue delivering power, provided that the remaining units can support the load power requirement. This allows users to create N+1 or N+M redundant systems.

Additionally, the “R” option increases the total number of units in a multi-unit system to 32. These units can be arranged to form Single-Phase, Split Phase, and 3-Phase systems. Systems with multiple phases will be N+1 or N+M redundant on each phase.

A failed unit can be removed and replaced while the remaining system unit AC outputs are active. Special consideration must be taken when connecting the outputs to avoid electric shock. It is strongly recommended that the system AC OUTPUT be disabled before a unit is removed or replaced.

CONFIGURATION cables for two, three, four and five unit Single-Phase systems are offered as standard products. See the following pages for details. These cables are unique to the “R” paralleling option, and cannot be used with “F” paralleling option units. Contact the SynQor factory for Single Phase systems larger than five UPS units.

Systems created using expanded parallel UPS units will be fault-tolerant to the following events:

- Complete loss of a unit’s INPUT power (AC INPUT, DC INPUT or BATTERY)
- Hardware failure of the AC INPUT stage
- Hardware failure of the AC OUTPUT stage

The enable and disable behavior of systems using expanded paralleling is different from systems using standard paralleling. For expanded paralleling, all UPS units will be enabled if one UPS is enabled. Units can be enabled by actuating their front-panel “ON” switches or by sending the appropriate signal over their USER I/O cables.

Sending a “OUTPUT DISABLE” command to a UPS will cause only that UPS to be disabled. Other UPS units in the system will continue running. Sending a “SYSTEM DISABLE” command over the RS-232 interface will cause all UPS units in a system to turn “OFF” simultaneously.

For a detailed description of the terminal interface see the SynQor website at: http://www.SynQor.com/UPS/documents/UPS_User_Commands.pdf

Parallel Configurations of the AC OUTPUTS: Up to Three Units

Multi-unit Configurations

The chart below shows four possible ways the AC OUTPUTS of up to three SynQor UPS units can be connected together. Each configuration will be discussed in more detail in the following pages.

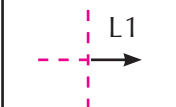
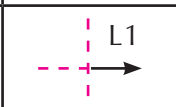
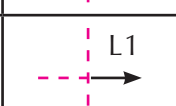
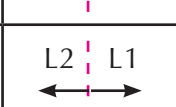
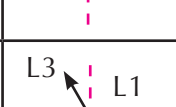
Number of UPS Units	Output Configuration	Phasor Diagram	# of Output Phases	Output Voltage	Output Current per phase	Total Output Power	Standard Parallel Configuration Cable	Redundant Parallel Configuration Cable
2	Parallel		1	L-N: $1 \times V_{rated}$	$2 \times I_{rated}$	$2 \times P_{rated}$	SYN-9311	SYN-9341
3	Parallel		1	L-N: $1 \times V_{rated}$	$3 \times I_{rated}$	$3 \times P_{rated}$	SYN-9315	SYN-9343
4	Parallel		1	L-N: $1 \times V_{rated}$	$4 \times I_{rated}$	$4 \times P_{rated}$	N/A	SYN-9344
5	Parallel		1	L-N: $1 \times V_{rated}$	$5 \times I_{rated}$	$5 \times P_{rated}$	N/A	SYN-9345
2	Series Split Phase		2	L-N: $1 \times V_{rated}$ L-L: $2 \times V_{rated}$	$1 \times I_{rated}$	$2 \times P_{rated}$	SYN-9313	N/A
3	3 Phase-Y		3	L-N: $1 \times V_{rated}$ L-L: $1.73 \times V_{rated}$	$1 \times I_{rated}$	$3 \times P_{rated}$	SYN-9317	N/A

Note that the chart shows the SynQor part number for the CONFIGURATION cable required for each configuration.

Parallel Configurations of the AC OUTPUTS: Up to 32 Unit "R" option

The "R" option adds a single pole electronic breaker to the hot wire of the AC OUTPUT. This breaker allows for fault-tolerant, glitch-free operation of up to 32 UPS units in a multi-system. Single-Phase, Split-Phase, and 3-Phase systems can be formed. These systems can be N+1 or N+M redundant on each phase.

The block diagrams below show a summary of the different system configurations that can be made using units with the "R" option. Please note that each multi-unit system requires its own unique system CONFIGURATION (Single-Phase, Split-Phase, and 3-Phase) cable. Contact the SynQor factory to purchase the system specific configuration cables. Note that configuration cables for two, three, four and five unit Single-Phase parallel systems are offered as standard products.

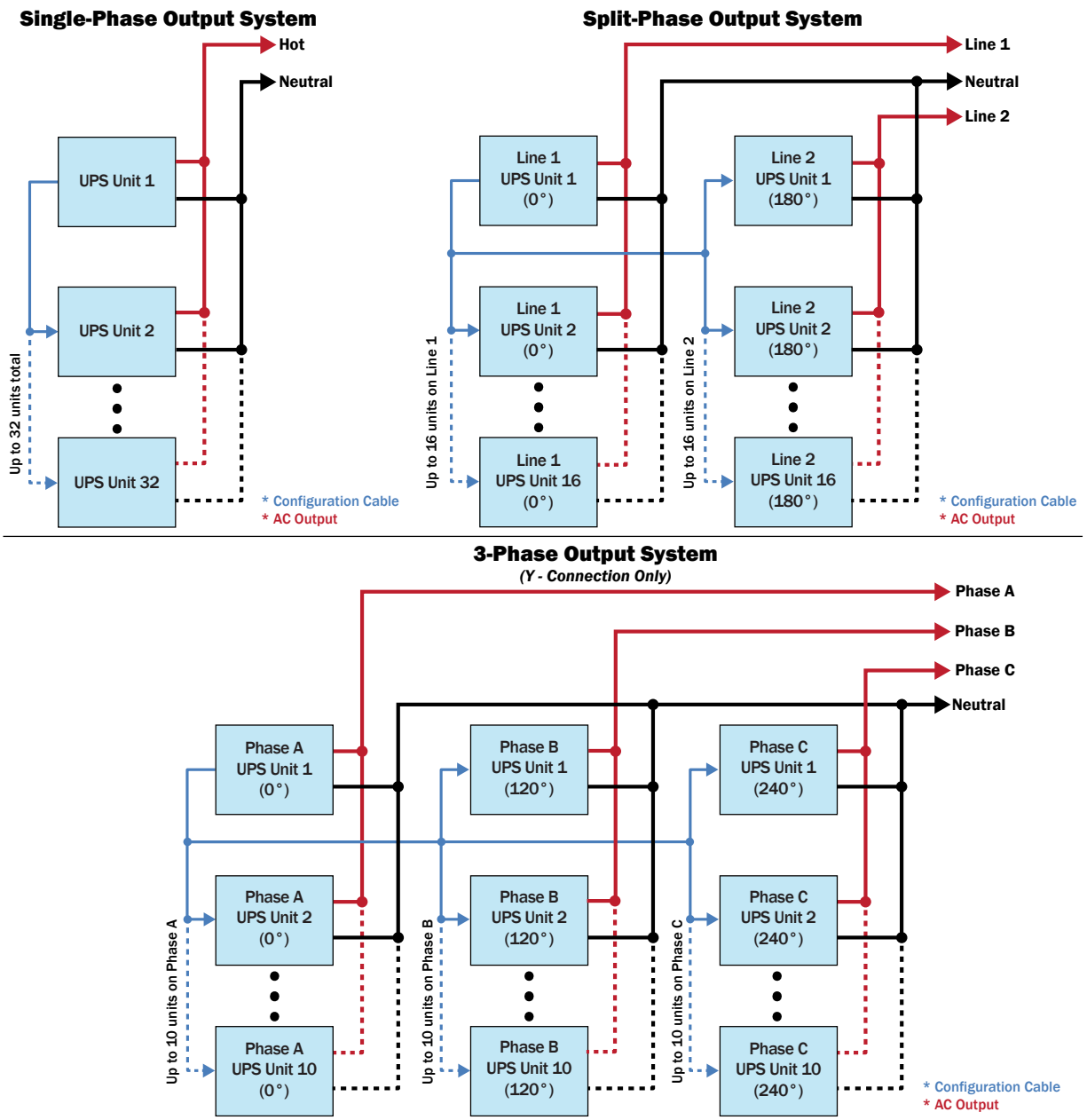

Parallel Connection of the AC OUTPUTS

Multiple UPS units can have their AC OUTPUTS connected in parallel to deliver to the load the sum of their combined output power and current. This configuration also allows redundant parallel units (type “R”) to form N+1 or N+M redundant systems.

Two UPS units with AC OUTPUTS Paralleled

The following diagram shows how to connect two UPS OUTPUTS in a standard or extended redundant parallel configuration. The wiring diagram explains how the AC OUTPUT cables and the CONFIGURATION cable need to be connected:

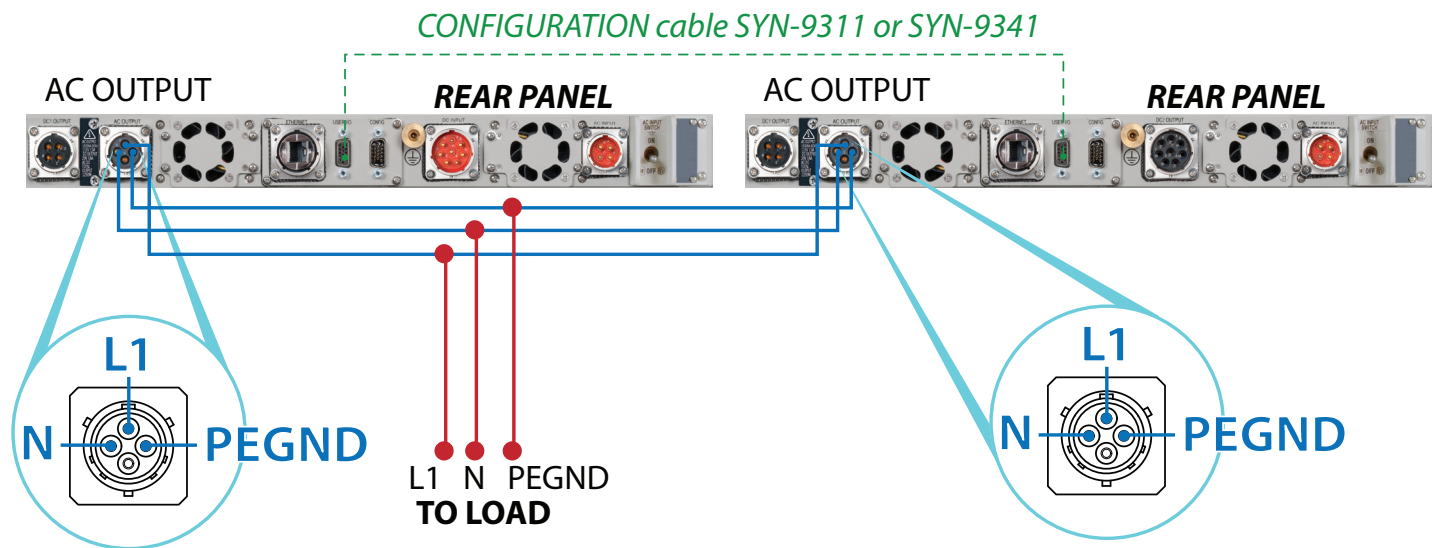

When ordering, select the “F: Floating” or “R: Redundant” option for UPS units configured in this manner. Use CONFIGURATION cable SYN-9311 for standard “F” type parallel and SYN-9341 for expanded redundant “R” type parallel units.

If the user is providing the AC OUTPUT cable, the cable size for the blue and red sections shown above should follow the guide lines in the table below depending on the output voltage configuration of the UPS units.

UPS AC OUTPUT Voltage	Blue Cable Section Minimum Wire Size	Red Cable Section Minimum Wire Size
115 Vac	#14 AWG (2.5 mm ²)	#10 AWG (6mm ²)
230 Vac	#16 AWG (1.5 mm ²)	#12 AWG (4mm ²)

Three UPS units with AC OUTPUTS Paralleled

The following diagram shows how to connect the output of three UPS units in standard or expanded redundant parallel configuration. The wiring diagram explains how the AC OUTPUT cables and the CONFIGURATION cable need to be connected:

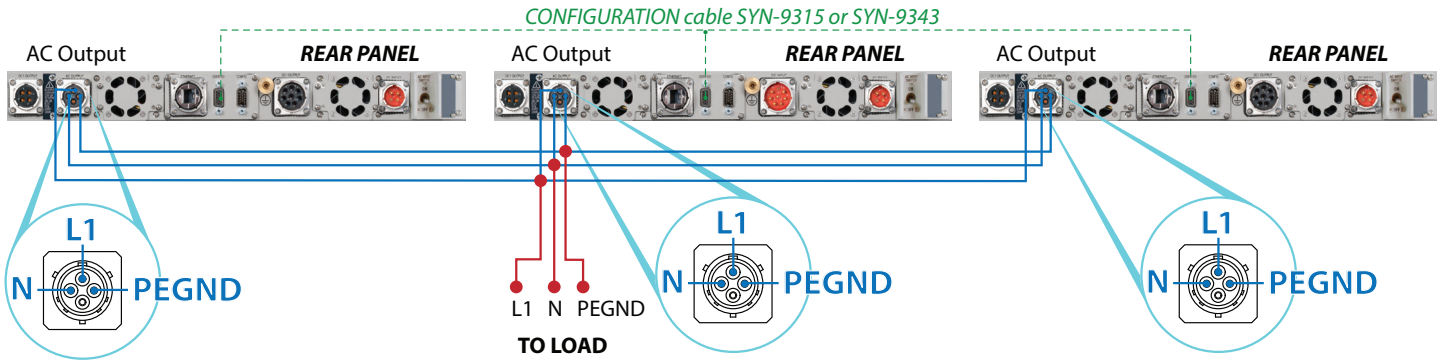

When ordering, select the options “F: Floating” for standard parallel, or “R: Redundant” for redundant parallel. Use CONFIGURATION cable SYN-9315 for standard parallel “F” Type and SYN-9343 for expanded redundant “R” type parallel units.

If the user is providing the AC OUTPUT cable, the cable size for the blue and red sections shown above should follow the guide lines in the table below depending on the output voltage configuration of the UPS units.

UPS AC OUTPUT Voltage	Blue Cable Section Minimum Wire Size	Red Cable Section Minimum Wire Size
115 Vac	#14 AWG (2.5 mm ²)	#10 AWG (6mm ²)
230 Vac	#16 AWG (1.5 mm ²)	#12 AWG (4mm ²)

Series Split Phase Connection of AC OUTPUTS

Two “F” type standard parallel UPS units can double the AC OUTPUT voltage by connecting both units in series. For instance, if each UPS unit is able to provide 115 Vac output, a series configuration would deliver a 230 Vac output at twice the power level of a single unit. Similarly, if the UPS units are able to provide 230 Vac output, the series configuration would deliver a 460 Vac output at twice the power level of a single unit.

The center node between the two outputs in the series configuration should be considered the “neutral” wire, and therefore kept at a potential as close to Protective Earth Ground (PEGND).

The other two AC OUTPUT wires are electrically “hot” (meaning at a high potential relative to the neutral or PEGND). One will be phase-shifted by 180 degrees (one-half cycle) from the other, meaning that when one hot wire is at its positive peak the other is at its negative peak, and vice versa. The voltage between these two hot wires is therefore twice that of either hot wire compared to the neutral wire. This configuration is called “Split-Phase”. When ordering, select the “F: Floating” option for the UPS units.

Contact the SynQor factory for N+1 expanded redundant Split-Phase systems. The wiring diagram for the AC OUTPUT cables and the CONFIGURATION cable for the Split-Phase configuration is shown below:

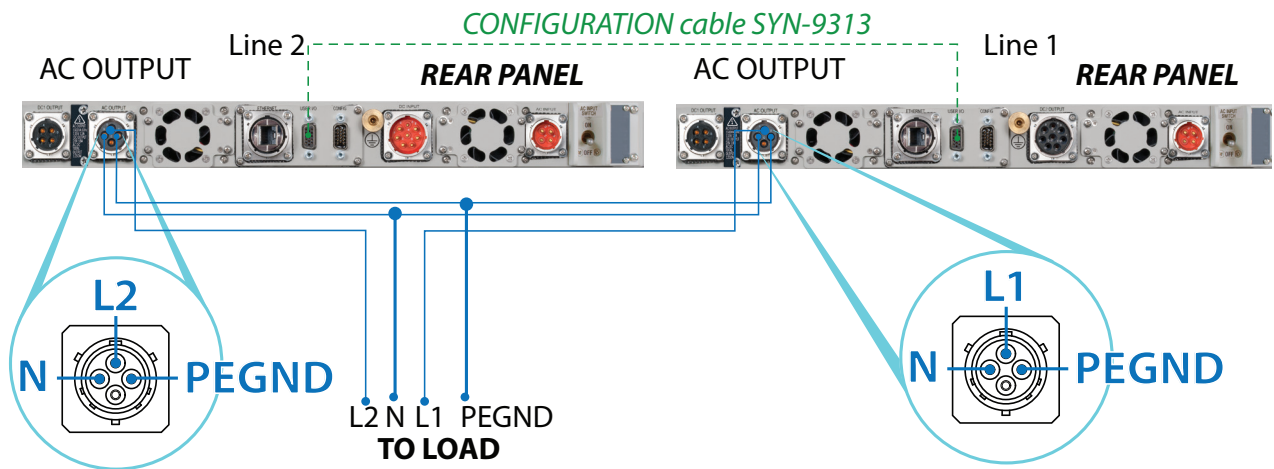

If the user is providing the AC OUTPUT cable, all the cable sections should have the following minimum wire size, depending on whether the AC OUTPUT of the individual UPS units is 115 Vac or 230 Vac.

UPS AC OUTPUT Voltage	Cable Minimum Wire Size
115 Vac	#14 AWG (2.5 mm ²)
230 Vac	#16 AWG (1.5 mm ²)

3-Phase Connection of AC OUTPUTS

Three standard “F” type parallel UPS units can be setup so that their AC OUTPUTS can share a common “neutral” and deliver output voltages that are phased by 120 degrees (one- third cycle) from each other. This configuration delivers a 3-Phase OUTPUT where the line-to-neutral voltage is the rated voltage of the individual UPS units (e.g. 115 Vac or 230 Vac line-to-neutral) and the line-to-line voltage is 1.73 times higher (e.g. 200 Vac or 400 Vac line-to-line).

Contact the SynQor factory for N+1 expanded redundant 3-Phase systems. The wiring diagram for the AC OUTPUT cables and the CONFIGURATION cables for the 3-Phase configuration is shown below:

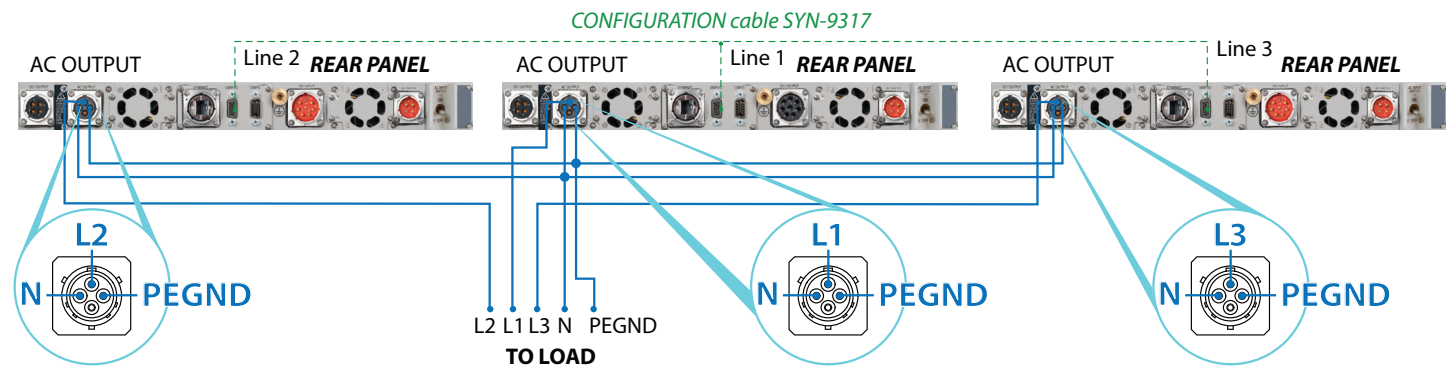

If the user is providing the AC OUTPUT cable, all the cable sections should have the following minimum wire size, depending on whether the AC OUTPUT of the individual UPS units is 115 Vac or 230 Vac.

UPS AC OUTPUT Voltage	Cable Minimum Wire Size
115 Vac	#14 AWG (2.5 mm ²)
230 Vac	#16 AWG (1.5 mm ²)

Note: The “neutral” wire of the 3-Phase AC OUTPUT should be kept at a potential close to Protective Earth Ground (PEGND).

When ordering, select the “F: Floating” option for UPS units.

Contact the SynQor factory for N+1 redundant 3-Phase systems.

Note: The three connectors of the SYN-9317 CONFIGURATION CABLE are labeled “Line 1”, “Line 2” and “Line 3”. The UPS unit that receives the “Line 1” connector will have an AC OUTPUT that is phased 120 degrees (one-third cycle) ahead of the UPS unit that receives the “Line 2” connector, which in turn will have an AC OUTPUT that is phased 120 degrees (one-third cycle) ahead of the UPS unit that receives the “Line 3” connector. Connecting the three AC OUTPUTS to the three line wires of the AC OUTPUT cable in the proper order may be important for some loads, such as motors.

Parallel Connection of DC OUTPUTS

The DC1 OUTPUTS are not parallelable between multiple modules. A direct parallel connection of DC1 OUTPUTS from different modules will result in a circulating power between the two UPS devices. Diode-ORing devices added externally at the DC1 OUTPUTS will prevent any circulating power. However, the outputs will still not necessarily share the load current equally.

DC2 OUTPUTS with the optional droop share feature can be directly paralleled for droop current share applications. Internal devices prevent circulating power between multiple units. Care should be taken to equalize the resistive drops between each unit and the load to maintain close matching of output current between multiple devices.

Connection of the AC and/or DC INPUTS

Whether there are two, three or more UPS units in the multiple-unit configuration, there are several ways that the AC and/or DC INPUTS can be connected to the input power sources:

- They could be connected to the same AC and/or DC source, respectively.
- They could be connected to different AC and/or DC sources, respectively.

All that is necessary for source input sharing is to ensure that the input voltage falls within the specified range of the AC and/or DC INPUT specifications of the individual UPS units.

Furthermore, the individual AC and/or DC INPUT cables can be first combined into a single cable (of appropriate minimum wire size), or they can be left as separate cables, each connected to the desired AC or DC source.

Note that the UPS INPUT fuses disconnect the unit from the AC INPUT bus should a UPS experience a hardware fault on its input stage. This feature, in conjunction with “R” expanded redundant option, allows for robust N+1 or N+M multi-unit fault tolerant systems.

Multi-unit AC OUTPUT “ON/OFF” Control – Standard Parallel (“F” option)

In multi-unit operation, all combined front panel “ON” switches must be actuated before any AC OUTPUT turns “ON”. Any “OFF” front panel switch actuation will cause all AC outputs to turn “OFF”. In addition, the “REMOTE-ON” or “REMOTE-OFF” rear panel input signal may be utilized for coordinated “ON/OFF” AC OUTPUT control. If any single UPS no longer has a valid input power source (e.g., no AC or DC INPUT and a depleted battery), the combined AC OUTPUT of the entire will shut down.

Multi-unit AC OUTPUT “ON/OFF” Control – Expanded Parallel (“R” option)

For expanded parallel multi-unit operation, any “ON” front panel switch actuation will cause all AC outputs to turn “ON” at once. The “REMOTE-ON” rear panel signal can also be used for a coordinated start.

Any “OFF” front panel switch actuation will cause only that specific unit to be deactivated. All other units will continue to function, assuming the load can be supported with the remaining active units. In addition, the “REMOTE-ON” or “REMOTE-OFF” rear panel input signal may be utilized to enable and disable one specific unit.

For coordinated shutdown, the user must send “SYSTEM DISABLE” over RS-232. See Section VI of the Operator’s Guide for details on the RS-232 interface. See UPS Terminal Commands document for more information on the “SYSTEM DISABLE” command.

AC OUTPUT Neutral Grounding

UPS units combined in multi-unit configurations must have the neutral floating “F” factory option to prevent the possibility of circulation protective earth currents. Expanded parallel units, “R” option, come with a floating neutral wire by default. If a grounded output neutral is required, then the output neutral should be connected to protective earth ground (PEGND) in a single spot. The size of the neutral-to-PEGND connecting conductor must be sized to match the largest combined AC OUTPUT neutral conductor specified in the wiring diagrams above.

Wiring Caution

WARNING: LETHAL VOLTAGES MAY BE PRESENT ON UPS AC OUTPUT CONNECTIONS. ALWAYS REMOVE BATTERY PACKS AND INPUT POWER BEFORE MAKING MULTI-UNIT AC OUTPUT CONNECTIONS. ALL AC OUTPUT CABLE CONNECTORS MUST BE INSTALLED DURING OPERATION AS A DISCONNECTED CABLE CONNECTOR MAY HAVE EXPOSED VOLTAGE PRESENT FROM ANOTHER UNIT IN THE GROUP.

Battery Technology

The battery packs for the UPS-1500 Series contain Lithium Ion rechargeable batteries. For a given amount of energy storage they are much smaller and lighter than a lead-acid battery. They are capable of very high discharge rates and fast recharging, and can do so over many cycles and over a long life. As such they are very suitable for a UPS application. Lithium Ion batteries are used in many military applications.

Electronic Circuitry within the Battery Pack

The SynQor battery pack has electronic circuitry within it that:

- controls the charging (including the equalization charging) of the battery
- separates the battery cells into multiple segments
- provides protection of the battery
- runs diagnostics on the battery
- controls the battery pack's front panel LED indicators

The purpose of separating the battery cells into multiple segments is to allow the battery pack to remain useful even if one of its battery cells fails. In a normal battery configuration, the failure of a single cell would disable the entire battery. The SynQor battery packs are designed with their battery cells arranged in segments that can be disconnected from the other segments by the internal electronic circuitry. Therefore, if a battery cell fails in one segment, the battery pack can still operate with the remaining segments (at a reduced battery run-time) until the battery pack can be serviced.

There are two battery packs offered for the SynQor UPS products: BAT-0200 and BAT-0400. These packs have 3 and 4 battery segments, respectively. The BAT-0200 and BAT-0400 batteries are applicable to the UPS-1250-[S,H,M]-[1U,2S], UPS-1500-[S,H,M]-[1U,2S], UPS-3000-[S,H,M]-2U devices.

The protection features provided by the electronic circuitry include:

- **Maximum Current Limit** when the battery is being charged/discharged
- **Charging/Discharging Protections** to avoid over-charging/discharging of the battery
- **Charging/Discharging Lockout** if the battery is too hot or too cold
- **Disconnect** of the battery from the battery pack's terminals when the pack is not inserted into the UPS

Battery Capacity

SynQor offers multiple battery packs in a sub-1U high form factor, the BAT-0200 and the BAT-0400. The BAT-0200 weighs 10 lbs. and has 3 battery segments. The BAT-0400 weighs 11.8 lbs. and has 4 battery segments. All battery packs will recharge in about two hours. The run-time as a function of UPS load power is shown on the below table.



Total UPS Output Power	BAT-0200 Run-Time	BAT-0400-H Run-Time	BAT-0400-M Run-Time
100% Rated Power	> 10 Minutes	> 13.5 Minutes	> 16 Minutes
80% Rated Power	> 13 Minutes	> 18 Minutes	> 22 Minutes
60% Rated Power	> 21 Minutes	> 27 Minutes	> 34 Minutes

Storage of the Battery Pack

The storage temperature range of the battery pack (whether it is inserted in the UPS or stored separately) is -40°C to $+65^{\circ}\text{C}$ (-40°F to $+150^{\circ}\text{F}$). Long term storage outside this temperature range will lead to a permanent reduction in the battery's energy storage capacity. The optimal storage temperature is below 35°C . Storage above this temperature will accelerate battery degradation.

Battery Pack Replacement

UPS-1250-S-1U and UPS-1500-S-1U products ship with the BAT-0200 battery pack. UPS-1250-H-1U and UPS-1500-H-1U products ship with the BAT-0400-H battery pack. UPS-1250-M-1U and UPS-1500-M-1U products ship with the BAT-0400-M battery pack. However, the three packs are interchangeable; for example, a BAT-0400-M battery may be installed in an existing UPS-1500-S-1U device as an upgrade to the performance. The table below shows the applicable battery packs for various series of SynQor UPS devices.

UPS Series	BAT-0200	BAT-0400-%
UPS-1250-[S,H,M]-[1U,2S]	Qty. 1	Qty. 1
UPS-1500-[S,H,M]-[1U,2S]	Qty. 1	Qty. 1
UPS-3000-[S,H,M]-2U	Qty. 2	Qty. 2

Always use the proper SynQor battery pack.

Handling the Battery Pack

The operating temperature range of the battery pack is -20°C to $+55^{\circ}\text{C}$ (-4°F to $+130^{\circ}\text{F}$). The battery pack's internal electronic circuitry will disable the battery if the cell temperatures are outside this temperature range. The SynQor UPS is equipped with internal battery heaters which activate to keep the cells above 0°C in cold ambient temperatures. Therefore, the UPS can be used at ambient temperatures as low as -40°C when input power is available to operate the battery heaters.

Additionally, the BAT-0400-M pack has the capability of powering the battery heaters from internal battery energy. This enables coldstart operation down to an ambient temperature as low as -40°C . During coldstart self-heat, the battery heaters run in a high power mode capable of bringing the battery to operational temperature in about 3.5 minutes.

When the battery pack is not inserted into the UPS, the internal electronic circuitry disconnects the battery from the pack's power terminals. Nevertheless, care should be taken to avoid making metal contact with (or between) any of these terminals.

The battery pack has its own aluminum chassis that protects its battery cells and internal electronic circuitry from the environment when the pack is not inserted into the UPS. However, care should be taken to ensure this chassis and the exposed power terminal strip is not subjected to extreme mechanical shock or to excessive moisture.

UPS battery packs must be shipped per Federal DOT Regulations as a Class 9 Fully Regulated Hazardous Material. The battery pack must not be installed in the UPS when being shipped, and it must be packaged in the original SynQor Shipping Carton (including inner protective inserts) which has been approved for shipping this product. The shipping carton must be appropriately labeled per applicable Federal DOT Requirements. A UPS may be shipped using standard shipping methods if it does not contain a battery pack. Please contact SynQor for further assistance.

The battery pack should be disposed in accordance with applicable regulations of the locality or returned to a factory-authorized Service Center.

Emergency response contact information for battery damage, leaks, smoke, or fires can be found at the following link: <http://www.SynQor.com/UPS/documents/Contact.pdf>. Please contact the SynQor factory for all other questions regarding the UPS battery pack.

CAUTION: Do not dispose of batteries in a fire. The batteries may explode.

CAUTION: Do not open or mutilate batteries. Released electrolyte is harmful to the skin and eyes. It may be toxic.

Always use the proper SynQor battery pack. See the battery replacement chart on page 45.

Control Cable Connections

There are two high-density (three-row) DB15 connectors located on the rear panel of the UPS:

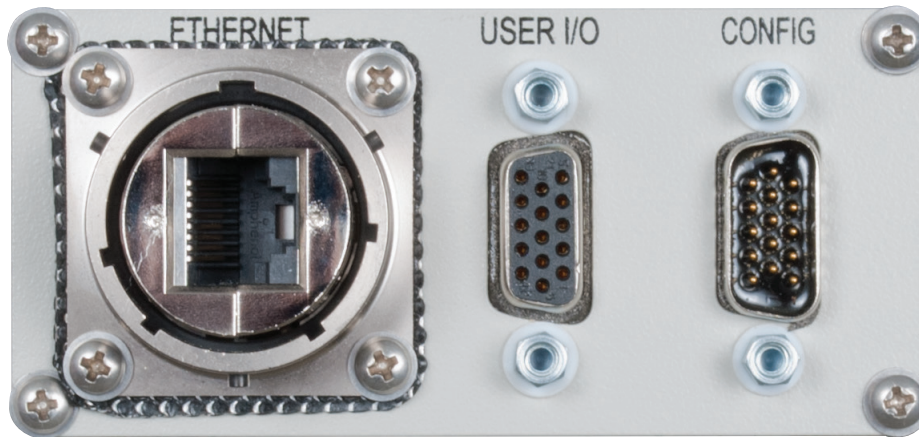

The User I/O female DB15 connector on the left is for an optional connection to a host/system computer so that it can control the UPS and receive information regarding the status of the UPS.

The Configuration male DB15 connector on the right is for a connection between SynQor UPS units in standard and expanded paralleling configurations. The port is used in conjunction with the paralleling CONFIGURATION cables to exchange load sharing information and coordinate startup/shutdown operations between parallel UPS units.

The designation/location of the pins for the User I/O female high-density DB15 connector are shown below:



Internal User I/O Circuits

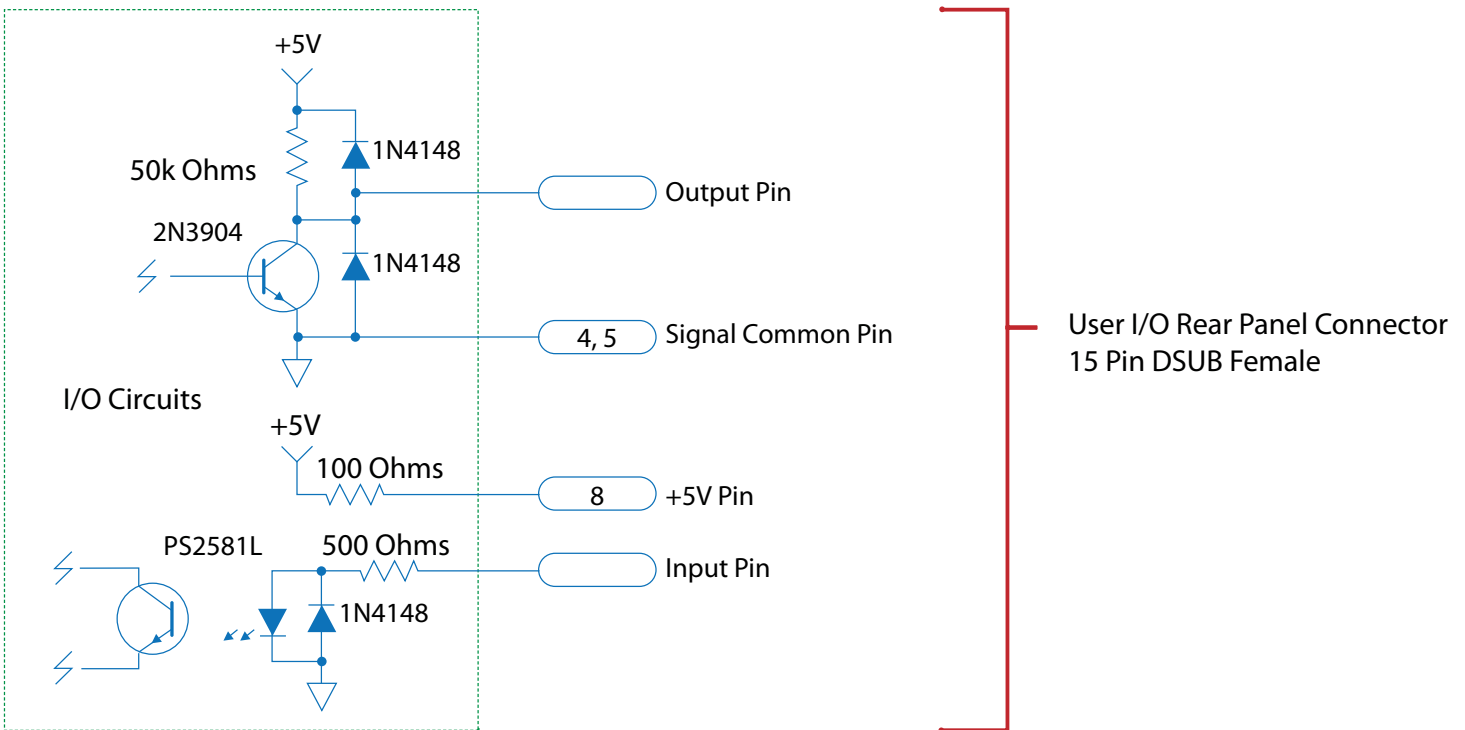

Remote On/Off Switch Connections

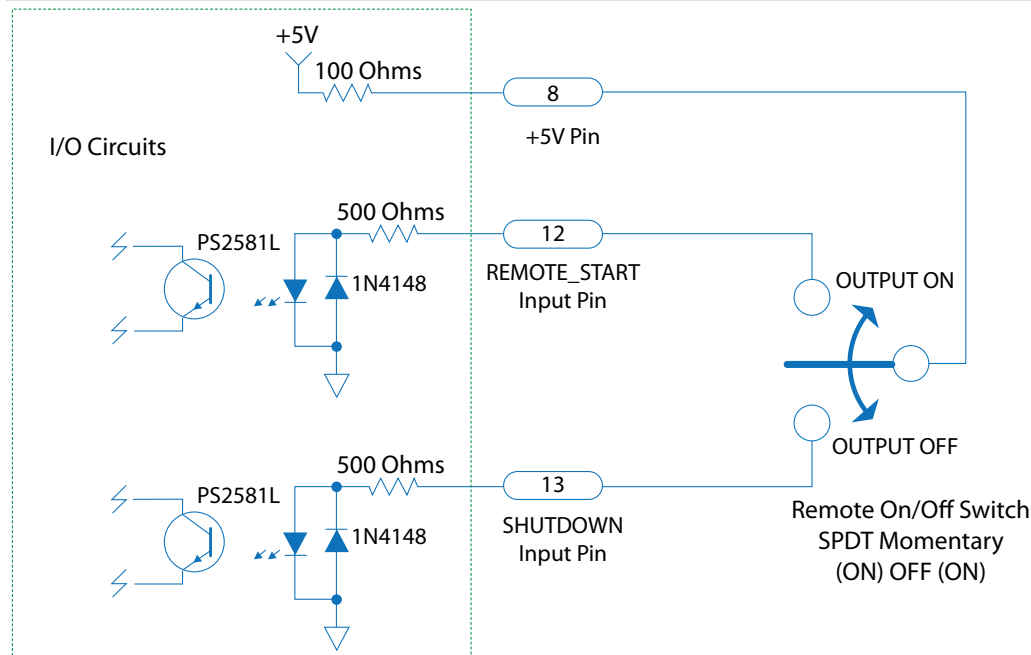

Note: A 2PDT or 3PDT switch may be substituted for single control of 2 or 3 UPS machines, respectively.

Digital Input/Output Control Signals

There are 2 input and 5 output digital signals available on the User I/O female high-density DB15 connector. The pin assignments and functions of these digital I/O signals are as follows:

Signal	Pin Number	Function
+5 V	8	Bias voltage with minimal current drive usable as a pull-up voltage for the open collector output signals (100Ω source resistance)
GND	4 and 5	Ground reference for all digital inputs and outputs
$\overline{\text{LOW_BATT}}$	6	Open collector* output where “low” indicates battery charge level is <10%
$\overline{\text{ACIN_GOOD}}$	7	Open collector* output where “low” indicates AC INPUT voltage is within range
$\overline{\text{ON_BATT}}$	9	Open collector* output where “low” indicates the UPS is drawing power from its battery
$\overline{\text{OUT_OK}}$	14	Open collector* output where “low” indicates AC OUTPUT voltage is within range
$\overline{\text{OVER_TEMP}}$	15	Open collector* output where “low” indicates that the UPS is at or above its maximum temperature
REMOTE_START	12	Drive this line “high” with $\geq 5\text{mA}$ to enable the UPS outputs
SHUTDOWN	13	Drive this line “high” with $\geq 5\text{mA}$ to disable the UPS outputs

*with an internal 50 kΩ Pull-up Resistor to 5 V and ESD Protection Diodes.

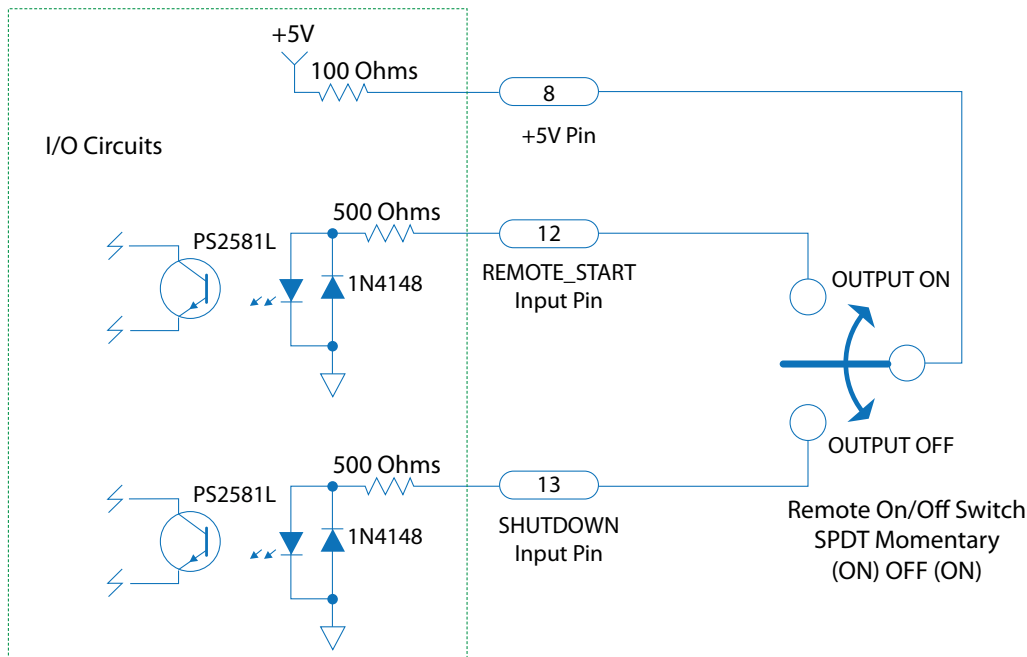

RS232 Serial Interface

The same User I/O female high-density DB15 connector also provides for an RS232 interface between the UPS and the host/system computer. The interface has a 115.2 k baud with eight data bits, no parity bit and one stop bit. The pin assignments and functions for this RS232 interface are as follows:

Signal	Pin Number	Function
GND	4 and 5	Ground reference for RX and TX signals
RX	3	RS232 DCE/UPS Device Receive signal
TX	2	RS232 DCE/UPS Device Transmit signal

The RS232 port provides readback of UPS’s state, as well as the configuration and control of the UPS’s operation. The port can be used from a standard terminal interface, or from a custom computer application.



UPS-1500-S-1U with DC Input/DC1 Output Option

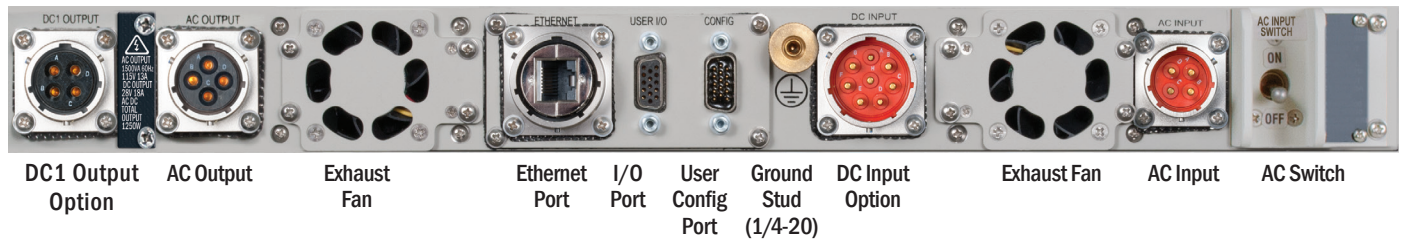

UPS-1500-S-1U with DC1 Output/DC2 Output Option

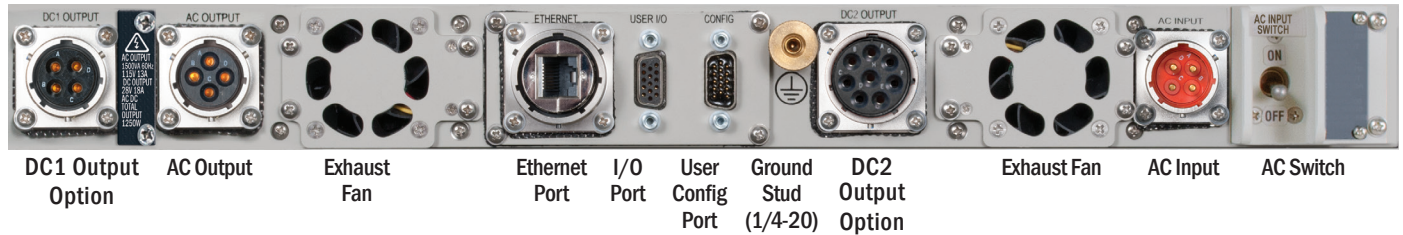

Readback information that is available:

- AC INPUT Voltage
- AC INPUT Current
- AC INPUT Frequency
- DC INPUT Voltage
- AC OUTPUT Voltage
- AC OUTPUT Current
- AC OUTPUT Power
- AC OUTPUT Frequency
- DC OUTPUT Power
- Total OUTPUT Power
- Battery Voltage
- Battery State of Charge
- Battery Predicted Run Time
- Number of Battery Cycles
- External Switch Input Status
- Fan RPM
- Internal Temperatures

Parameters that are controllable through the interface:

- Output enable / disable
- Alarm enable / disable
- Fan diagnostics

For a detailed description of the terminal interface see the SynQor website at:

http://www.SynQor.com/UPS/documents/UPS_User_Commands.pdf

Ethernet Interface

The Ethernet interface provides a web page based user interface for monitoring and control of the UPS. The user can configure email alerts for UPS alarm conditions. The interface also provides a RFC-1628 compliant remote SNMP monitoring interface for the unit.

The Ethernet interface supports 10BASE-T and 100BASE-T standards. It utilizes a standard RJ-45 connector, also allowing a metallic sealable circular military outer housing. The interface supports auto-negotiation, polarity correction, and Auto-MDIX (detection and use of straight through or cross-over cables).

IP address assignment can be done automatically via DHCP, or a user static address entry. The interface also supports a direct connection between the UPS and a host computer by including a local DHCP server internal to the UPS.

For a detailed description of the Ethernet port and SNMP implementation see the SynQor website at: http://www.synqor.com/ups/documents/UPS_Ethernet_SNMP_UG.pdf

Battery

The lithium ion battery cells in the battery pack do not need any maintenance. In particular, unlike a lead acid battery, a lithium ion battery does not need to be re-charged on a regular basis to avoid degradation of its energy storage capacity. Care should only be taken to ensure that the battery storage temperature is within the specified -40 °C to +65 °C (-40 °F to +150 °F) range.

Emergency response contact information for battery damage, leaks, smoke, or fires can be found at the following link.

<http://www.SynQor.com/UPS/documents/Contact.pdf>

Please contact the SynQor factory for all other questions regarding the UPS battery pack.

CAUTION: Do not dispose of batteries in a fire. The batteries may explode.

CAUTION: Do not open or mutilate batteries. Released electrolyte is harmful to the skin and eyes. It may be toxic.

Always use the proper SynQor battery pack. See the battery replacement chart on page 45.

Fans

The fans on the rear panel have sealed bearings that do not require any regular maintenance. Fan assemblies are user replaceable with kits available from SynQor. Please contact the SynQor factory for obtaining fan replacement kits.

Cleaning

The UPS-1500 unit has a sealed chamber for its electronics and the battery pack that is weather-proof. Only the fans on the rear panel are exposed to the environment, and these fans are also weather-proof. The unit can therefore be cleaned without concern of getting liquids inside the chamber. **NOTE**, however, that if the cables have been removed from the connectors the connectors should have their covers installed to protect the connector from damage, contamination or corrosion. If connectors are not protected, then care should be taken to not get excess liquid on the connector terminals. **ALSO NOTE** that care should be taken to not get excess liquid on the back panel AC SWITCH.

Cleaning should be done either with soap and water or with an Isopropyl alcohol and water mixture. A soft cloth should be used.

Do not immerse the unit in water to clean it.

Fault Conditions

The SynQor UPS has no user-serviceable parts within it other than the cooling fans. If the unit has an internal malfunction only factory trained personnel should attempt to repair it.

There are, however, several external conditions that could cause the UPS to not operate as desired. These external conditions can likely be corrected by the user.

The 16 LEDs on the front panel of the battery pack are the best and first place to look to determine what might be wrong with the UPS. The table on the next several pages is therefore organized by what these LEDs indicate, and for each indication there is a listing of what might possibly be wrong.

The front panel battery pack LED array is shown below. The designations of the 16 LEDs in this array are used in the following table.

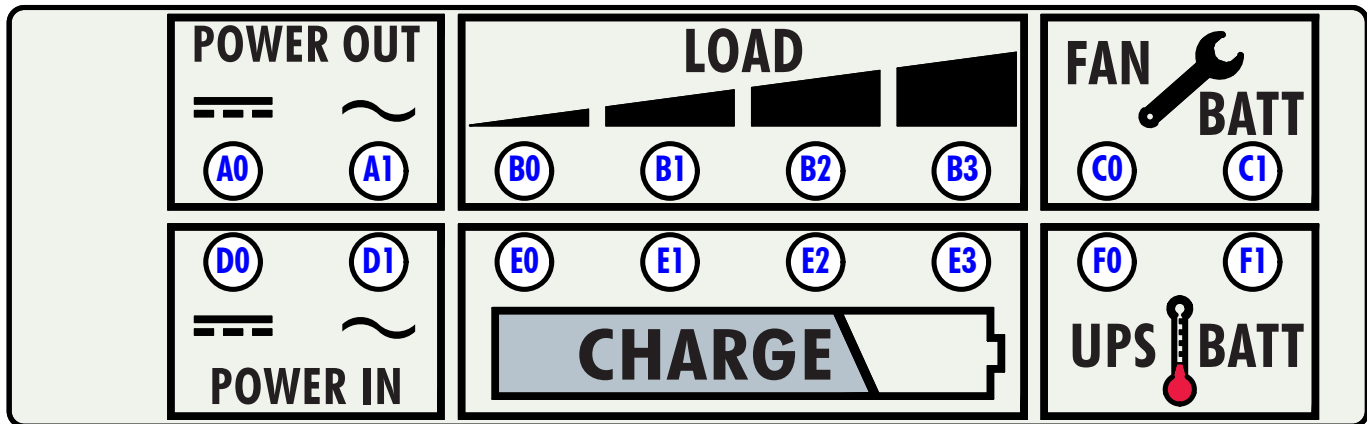

LED	Indication	Possible Problem(s)
D1: AC INPUT Power LED	LED is OFF	<ul style="list-style-type: none"> •The AC INPUT power source is not turned “ON”. •The AC INPUT cable is not connected or it is wired wrong. •The AC SWITCH on the rear panel is “OFF”. •The AC INPUT voltage is either too low or too high.
	LED is a STEADY GREEN and not a PULSING GREEN. UPS is instead running off the optional DC INPUT or the BATTERY	<ul style="list-style-type: none"> •The AC INPUT voltage is within its proper range but the UPS is not selecting it for its source of power. •The AC INPUT voltage and the total load power may exceed the power derating curves given earlier in this Guide. •The AC INPUT cable may have too much series resistance. Thicker wire should be used.
D0: DC INPUT Power LED	LED is OFF	<ul style="list-style-type: none"> •The optional DC INPUT is not available on this unit. •The DC INPUT power source is not turned “ON”. •The DC INPUT cable is not connected or it is wired wrong. •The DC INPUT cable is connected to the DC source with the wrong polarity. •The DC INPUT voltage is either too low or too high •The DC INPUT cable may have too much series resistance. Thicker wire should be used.
A1: AC OUTPUT Power LED	LED is OFF	<ul style="list-style-type: none"> •The UPS is “OFF” and needs to be turned “ON”.
	LED is AMBER	<ul style="list-style-type: none"> •The AC OUTPUT load is higher than 1250 W or 1500 VA by enough to trigger the power limit circuitry. •The AC OUTPUT load crest factor is too high. •The AC OUTPUT is shorted within the cable or a load. •Some other source of power is connected to the AC OUTPUT.
	LED is RED	<ul style="list-style-type: none"> •The UPS has been turned “OFF”, but due to a malfunction within the UPS it is still running and providing an AC OUTPUT voltage. •Some other source of voltage is connected to the AC OUTPUT and is powering it when the UPS is not.
A0: DC OUTPUT Power LED	LED is OFF	<ul style="list-style-type: none"> •The optional DC OUTPUT is not available on the unit. •The UPS is “OFF” and needs to be turned “ON”.
	LED is AMBER	<ul style="list-style-type: none"> •The DC OUTPUT load is higher than 500 W. •The DC OUTPUT is shorted within the cable or a load. •Some other source of power is connected to the DC OUTPUT.
	LED is RED	<ul style="list-style-type: none"> •The UPS has been turned “OFF”, but due to a malfunction within the UPS it is still running and providing an DC OUTPUT voltage. •Some other source of voltage is connected to the DC OUTPUT and is powering it when the UPS is not

LED	Indication	Possible Problem(s)
B0 – B3: LOAD Power LEDs	B3 is BLINKING RED	<ul style="list-style-type: none"> • Total UPS load power is greater than or approaching 1250 W. The UPS may still be delivering its specified output voltage because the load power is not high enough to trigger the power limit circuitry.
	B0 – B3 are all OFF	<ul style="list-style-type: none"> • No power is being delivered to the load. • The UPS is “OFF” and needs to be turned “ON”. • The loads or output cables are not connected. • The loads are all turned “OFF”. • The loads are simply not drawing any appreciable power at the time.
F0: UPS Cooling System LED	LED is BLINKING GREEN	<ul style="list-style-type: none"> • Indicates that the fans are running at 67% of their rated speed. There is no problem.
	LED is AMBER	<ul style="list-style-type: none"> • Indicates that the fans are running at 100% of their rated speed. There is no problem, but the unit is operating at a high ambient temperature and a high load combination.
	LED is RED	<ul style="list-style-type: none"> • Fans are running at 110% of rated speed to keep the unit cool. The maximum recommended temperature may be exceeded, but the fans are keeping things cool enough to avoid triggering the over-temperature shut-down circuitry.
F1: Battery Pack Temperature LED	LED is BLINKING RED	<ul style="list-style-type: none"> • The battery is too cold to be charged or discharged without damage. • If the UPS is running from the AC INPUT or the DC INPUT the battery will eventually be warmed up and this condition will go away.
	LED is BLINKING AMBER	<ul style="list-style-type: none"> • The battery is too cold to be charged without damage, but it can be discharged if the UPS needs to draw power from it. • If the UPS is running from the AC INPUT, the DC INPUT or the battery, the battery will eventually be warmed up and this condition will go away.
	LED is STEADY AMBER	<ul style="list-style-type: none"> • The battery is too hot to be charged without damage, but it can be discharged if the UPS needs to draw power from it. • If the ambient temperature is within its specified range the battery will eventually cool down and this condition will go away.
	LED is STEADY RED	<ul style="list-style-type: none"> • The battery is too hot to be charged or discharged without damage. • If the ambient temperature is within its specified range the battery will eventually cool down and this condition will go away.

LED	Indication	Possible Problem(s)
C0: Fan Service Required LED	LED is AMBER	<ul style="list-style-type: none"> One or both fans have recently had degraded performance but seem to be ok now. The UPS is running a diagnostic test.
	LED is RED	<ul style="list-style-type: none"> One or both fans presently have degraded performance, even if they are running, and service is recommended at the earliest convenient time. Ensure that the fan blades are not obstructed from turning
C1: Battery Pack Service Required LED	LED is AMBER	<ul style="list-style-type: none"> The battery pack's calculated maximum energy storage capacity is <75% of its rated value. The UPS's battery run-time will therefore be similarly reduced. The battery pack should be replaced at the earliest convenient time if this derated battery run-time is unacceptable.
	LED is RED	<ul style="list-style-type: none"> The battery pack's calculated maximum energy storage capacity is <50% of its rated value. The UPS's battery run-time will therefore be similarly reduced. The battery pack should be replaced at the earliest convenient time.
All 16 LEDs:	All LEDs are OFF	<ul style="list-style-type: none"> The battery pack is not fully inserted into the UPS with its thumb screws tightened. The terminal on the battery pack is damaged or dirty. The battery pack is defective and needs to be replaced.
Audible Alarm: (pattern repeats every 5 seconds)	One tone	<ul style="list-style-type: none"> The UPS is drawing power from the battery pack and is discharging it. Sources of power should be restored or preparations made to shut down the loads.
	Two tones	<ul style="list-style-type: none"> The total UPS load power is above 1250 W. Loads should be reduced if this condition persists.
	Three tones	<ul style="list-style-type: none"> The AC OUTPUT has experienced either a short circuit or a load having a start-up surge current characteristic that the UPS could not start. The AC OUTPUT has therefore turned "OFF". The DC OUTPUT may still be powered. To reset, the UPS must be turned "OFF" and then "ON".
	Four tones	<ul style="list-style-type: none"> The UPS is drawing power from the battery pack and its remaining charge is <10% of its rated charge. Sources of input power should be restored or the loads should be shut down.

Two other conditions should be mentioned:

- The fans are “OFF” when the UPS is running

It is normal for the fans to be “OFF”, even if the UPS is running and delivering power to the load, as long as the temperature of the UPS is low enough. If the Fan Service Required LED (C0) is green, both of the fans are OK, even if they are not running.

- The UPS does not turn “OFF” when the “ON/OFF” switch is pushed down

When the “ON/OFF” switch on the front panel is pushed down, the UPS does not respond to this signal for approximately 1 second. This is done to ensure that the UPS is not accidentally turned “OFF”. If the user does not hold the “ON/OFF” switch in the “OFF” position for a full second before releasing it, the UPS will not turn “OFF”.

Other possible situations that are the result of external issues that a user could likely correct are related to:

- Loads that draw a large surge of current at start-up

Some AC loads draw a very large amount of current when an input voltage is first applied to them. This might happen when the UPS is first turned “ON” if the load is already connected to the UPS. Or it may happen when the load itself is turned “ON” and/or connected to the AC OUTPUT of a UPS that is already running. Common examples of such loads are motors and incandescent lights, but some electronic equipment can also display this characteristic.

Several problems could arise with such a load:

- The UPS fails to start the load:

The SynQor UPS is designed to try various start-up routines when it is first turned “ON” to overcome the problem of surge currents with some loads. There are five such routines (or repetitions of a given routine) that are tried. If the load is not started after these five routines are attempted, the UPS will turn “OFF”. To get the UPS to try again, the user should again push the “ON/OFF” switch on the front panel to the “ON” position. If the UPS cannot start the load, then it may be possible that a custom start-up routine could be devised to work with this particular load. Contact the SynQor factory for more information.

If there is more than one load connected to the AC OUTPUT that displays this start up surge characteristic and the UPS is not capable of starting all loads at once, it may be possible to switch “ON” the loads in a specific sequence, one by one allowing for a complete successful system power-up. For instance, if the UPS cannot startup with a load consisting of lights and an induction motor that has a startup current 5 times larger than the operating current, it may be possible to start the induction motor first. Once the motor has reached its normal operating speed and current, then the lights can be turned “ON” without triggering the UPS current limit protection.

- A newly started load disturbs the existing UPS loads.

A common problem can occur when the UPS is running and powering one or more loads connected to its AC OUTPUT, and then an additional load on the AC OUTPUT is turned “ON”. If this newly started load draws a large current surge at startup, it can cause the current limit of the UPS’s AC OUTPUT to be triggered, which in turn causes the output voltage to drop. The drop could cause existing loads to be disturbed. Furthermore, if the voltage drops far enough below the rated limit, the UPS will turn “OFF” its AC OUTPUT and initiate a new start-up sequence. This latter action could cause an interruption on the existing running loads.

If power disruption to the loads is a problem, the solution is to make sure loads with large startup surges are started first, and then proceed to start the rest of the loads.

- One of the 3-Phase AC INPUTS to the UPS is missing or out of range.

The UPS will detect a missing or out of range input phase and proceed to switch to the DC INPUT source if present, or if not present, to the battery backup. The UPS will continue to monitor the INPUT AC source and proceed to switch back automatically to the 3-Phase INPUT source once the problem has been corrected.

- INPUT Cable wire resistance is too high:

The resistance of the INPUT power (AC or DC) cable is too high due to an excessive cable length combined with an inappropriate cable size, loose panel/breaker terminals, connector contamination or corrosion. The accumulated resistance in the cable, drops the INPUT AC or DC voltage into the UPS below the rated limit during normal load conditions. This problem is more common in DC INPUT cables, since the DC INPUT current is high (as much as 65 A at full power) and the DC INPUT voltage is low (as low as 22 V). The phenomenon that may be displayed is as follows:

Assume for simplicity that the AC INPUT source is not present and DC INPUT source is present and within the specified voltage range. At standby, the UPS does not draw any or little power/current from the DC INPUT. The voltage drop across the DC INPUT cable from the source to the UPS is therefore negligible at this point.

The UPS sees that the voltage at the DC INPUT is within the specified range, and enables the output; the load begins to draw power which in turn requires the UPS to draw current via the DC INPUT cables and terminals. As the input current rises, a large voltage drop appears across the INPUT cable and terminals. If the voltage into the UPS drops below the minimum rated value of 22 V, the UPS may determine that the DC INPUT is out of range and proceed to switch to the battery source. After this occurs, no current is being drawn through the INPUT cables and terminals once again, so the UPS detects that the DC INPUT voltage is back to normal, and switches back to the DC INPUT source. This cycle will be repeated 3 times. At this time, the UPS will inhibit the DC INPUT source for 1 minute before trying again and starting the cycle again. The complete cycle will continue to repeat over and over, until the voltage drop in the input circuit is corrected or the battery backup is depleted.

If the battery backup becomes depleted, the UPS will proceed to shut down. Startup will require manually moving the “ON/OFF” switch to the “ON” position, even if the auto start feature is enabled in the UPS.

It is important to note that, this same problem can also occur in the 3-Phase AC INPUT lines, if the voltage at the AC source of any one phase is close to the 85 V_{L-VN} minimum AC INPUT limit. In this case the UPS will try ten times before stopping for a one minute interval and switching to a DC INPUT source if available, or the battery backup, if charged.

The following are possible solutions to this problem: 1) make sure that the cable diameter for the required length is sufficient to deliver the full amperage to the UPS unit (See the section “Power Cable Wire Size” for recommended cable wire sizes), 2) tighten the distribution panel/breaker terminals or 3) clean any contamination or corrosion buildup on all terminals and connectors.

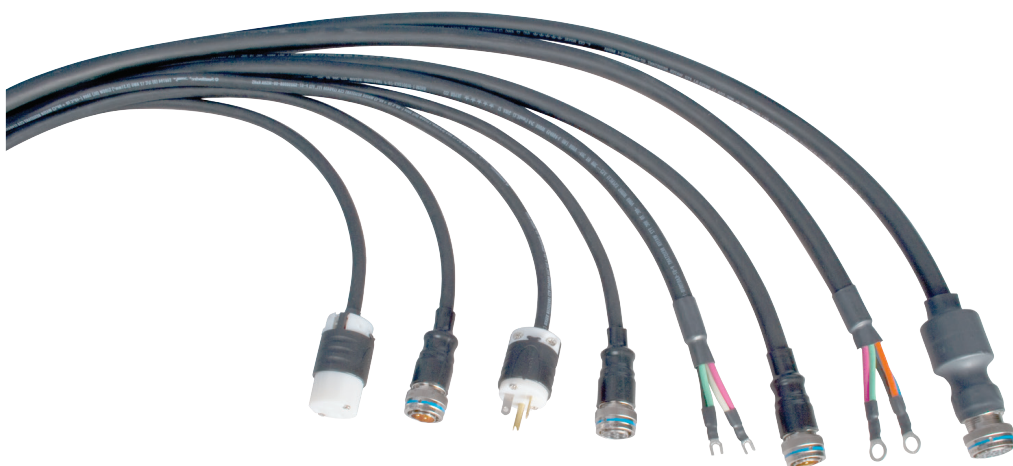

UPS **MILITARY FIELD-GRADE**

UNINTERRUPTIBLE POWER SUPPLY

Operator's Guide *3-Phase UPS-1500 Series*



Made in USA

006-0007129

09/12/2023

REV E

SynQor[®]
Advancing The Power Curve[®]